

SWI-TEC®



ALWAYS AN IDEA AHEAD...



2022

BOAT ACCESSORIES ONLINE SHOP

www.swi-tec.com



A lot of news from our company

This year we convince not only with our innovative products but also with our new and fresh look. Catalogue and Online-Shop blaze in a new layout and you can find us on all current social media channels.

In 2011 we transformed SwissTech into SWI-TEC in order to integrate it under one common roof with our manufacturing company Neveta Náutica S.L. SWI-TEC stands for ‚Special. Water. Innovation‘, i.e. for everthing related to practical, clever and unique ideas around vessels and water.

For over 20 years our philosophy has remained unchanged: We develop special products for everyday use on board to make life a little easier for you. We use high-quality materials for production so as to offer you yacht accessories with extreme durability and high quality – our products are there to make you enthusiastic every time you use them.

All products from Neveta Náutica that are presented under the SWI-TEC trademark are designed, produced, tested and marketed by our team.

Follow our mascot Maxi through the catalogue and he will give you for sure some very nice tips, including our SWI-TEC video animations which you can find on our website.

We hope that you will enjoy our new catalogue – and may there always be an inch of water under your keel!

Your SWI-TEC crew



Content and News 2021/2022



Mast Ascension

- 6 SWI-TECMastlift
Protective Cover
- 7 Mastlift Details
- 8 Bosun's Chair
Mastlift Universal Bag
- 9 Mastlift Accessories
Guide Roller
Endless Line
Masthead Harness
- 10 Mast Ladder
Mast Steps
- 11 Lifting Aid for wheelchair users
*Getting on board from a wheelchair:
Now it becomes easy and safe*



Anchoring

- 25 **NEW!** Chain Claw
Now also available for super yachts
- 26-28 Self-Adjusting Anchor Buoy
Anchor Buoy Accessories
Illumination
You can see your Anchor-Buoy also during the night
Adhesives
- 29 Chain for Mooringbuoys
No more chafed ropes on Mooringbuoys
Stabilizer
- 30 Anchor Chain & Chain Markers
- 31 Anchor - original BUGEL & Powerball



Help Aboard

- 12-15 Hydro Charger
Charge your batteries under sail
- 16 Scarecrow «Universal»
No more birds fouling your boat!
Scarecrow «Standard»
- 17 Accessories for the Universal Scarecrow
- 18 Accesories for the Scarecrow Universal
and Standard
- 19 Scarecrow for Mast-Top y spreaders
- 20 Outboard motor lift
Lifting Harness for outboard-motors
- 21 Rat Guard
*New sizes - also for commercial shipping and
super yacht*
- 22 Dinghy Support
- 23 Fenderholder for stanchios
now also available in white
Mould resin
- 24 Turnbuckle Cover
Sail Tie
RopeFix



Mooring

- 32 Retrieving Hook
- 33 Boat Hook
Anchor Clearing Hook
- 34 Mooring Line Hook for Lazy Lines
Easy mooring in the Mediterranean Sea ports
- 35 Safety Lock
Mooring Line Tensioner



Sun, Wind and Weather

- 36 **NEW!** Sun Awning Kit
suitable for motor and sailboats
- 37 Wind Scoop
Mosquito-net / Tenax
Reliable protection against insects
- 38 FixTop & RollTop
Provides shades on your boat
- 39 Winch Cover
Turnbuckle Cover



Security

- 40 Burglar Bars for Hatches
- 41 Emergency Ladder
- 42 Sailboat-Burglar Lock
«Standard»
«Deluxe»
Development for your security



Gangways & Accessories

- 43 - 44 Gangways
A big range of gangways!
Custom sizes built to order!
- 45 **NEW! Non-slip mat for gangway**
Perfect for dogs and cats on board
Gangway Bag
Gangway Bracket
- 46 Gangway Holders



Bags

- 47 Sail Repair Kit
Toolbag
- 48 Combi bag
Universal bag mini
Bag for maps
- 49 Universal Storage bag
Storage bag
Mast Sheet Bag for halyard
- 50 Multi-purpose bag
Storage bag for winch handle
Storage bag for Ropes



Others

- 51 Garlic Press
Salt- and Pepper shaker
- 52 Drink- and Bottleholder
- 53 Screw carry cases & Rivet fastener

- 54 Introducing SWI-TEC
- 55 International SWI-TEC Dealerlist

SWI-TEC®



Mast Ascension

SWI-TEC Mastlift



Video Demo
www.swi-tec.com



Give yourself a lift!

- Safe mast climbing
- Work alone at the top of the mast
- Both hands are always free
- No need for extra mast fittings
- Just hoist the Mastlift on the halyard of your choice (preferably two halyards for extra security)
- Reduction ratio: 10 : 1
- Multi purpose - Man overboard Recovery, General hoist
- Available in two sizes (height of mast: to 45ft and to 82ft)

The endless line is included.

| | | |
|----------------------------|--|---------|
| Art. No. | 1001 | 1002 |
| Useful height: | to 13m | to 25m |
| Gear ratio: | 1:10 | 1:10 |
| Weight: | 6,7 kg | 7,6 kg |
| Size: | $\varnothing = 165 \text{ mm}; L = 215 \text{ mm}$ $\varnothing = 185 \text{ mm}; L = 215 \text{ mm}$ | |
| Permitted Live Load: | 150 kg | 150 kg |
| Breaking Load Dyneemaline: | 2100 kg | 2100 kg |
| Material: | Stainless steel (V4A), aluminium, high impact plastic | |



German Lloyd certified!



Please give us the exact mast height when placing an order.



Mastlift Accessories: Protective Cover



We recommend our Neoprene Protective Cover to protect the unit and your mast.

Protects:

- the unit and the mast from impacts during operation
- the unit during storage
- eliminates chafing at the masthead

| | |
|-----------|----------------------------|
| Art. No. | 1005 |
| Sizes: | for 13 m and 25 m mastlift |
| Material: | 7 mm neoprene |
| Weight: | 0,5 kg |



SWI-TEC Mastlift



Mast Ascension

Bosun's Chair «Standard» and «XXL»



Safe and comfortable!

- With stitched-in wooden board
- Comfortable to sit on for hours of work
- Safe even if unconscious
- Strong fabric and workmanship
- 4 sewn-on bags for power tools, rigging tools, nuts and bolts etc.
- Sewn-in stainless steel shackle
- Compact storage bag included
- Fittings to hold drill
- Additional stitched loops for tools

XXL-Design

- Addition: Adjustable back-rest
- Larger wooden board
- Wider

★ **A great asset to your safety, our Bosun's Chairs are safe even in the event of loss of consciousness.**



| Art. No. | 2001 | 2000 |
|--------------------------------|--|---------|
| Bosun's Chair: | «Standard» | «XXL» |
| Weight: | 2 kg | 3,7 kg |
| Permitted Live Load: | 150 kg | 170 kg |
| Strength of load bearing line: | 2170 kg | 3000 kg |
| wooden board: | 15 mm | 20 mm |
| Material: | Cotton-polyamid blend, water resistant | |
| Waist circumference: | 125 cm | 145 cm |

Mastlift Accessories: Universal Bag



A sturdy, attractive and versatile bag on board or at home!

- The mastlift is always at hand
- The perfect bag for the mastlift and its accessories
- Keep dampness out

| Art. No. | 3009 |
|-----------|---|
| Material: | cotton and polyamid blend with foam rubber inside |
| Weight: | 0.8 kg |
| Size: | 400 x 250 x 250 mm |



Mastlift Accessories: Guide Roller



Allows the use of mastlift at sea!

- To be used around the furled genoa or jib
- Using the Guide Roller will prevent the mastlift hitting the mast
- Can also be used as a guide for light sails

Art. No. 1003

Material: Turned from solid beech wood,
cable stainless steel

Size: 700 mm



Mastlift Accessories: 4 m Endless Line



May be used as a hoist in the following situations!

- Man over-board retrieval
- Lifting an outboard motor or recovery of a dinghy
- Lifting heavy equipment for example, batteries and generator etc.



Art. No. 1004

Size: 4 m

Line: Ø 10 mm spliced



Mastlift Accessories: Masthead Harness



Enables you to work above the masthead!

- The Masthead Harness ensures safety as you work at the masthead
- Ideal for the installation or repairs of masthead equipment
- Adjustable to any body size



Art. No. 1006

Material: 50 mm polyester

Load: 1000 kg



Mast Ascension

Mast Ladder



Perfect for small masts!

- Adjustable rollers to adapt to mast-section
- Work single handed at the top of the mast
- Simple application
- No fittings necessary
- Attaches to any mast
- Perfect control with track slides (not included)



Important:

When climbing use safety line and a second person!

Art. No. 5001

Mast Ladder

for mast heights up to 10 m /16 steps / Material: Aluminum

Art. No. 5002

Ladder extension

2 m ladder length / 5 steps

Art. No. 6006

Bag for ladder

100% PVC

Size: 48 x 26 x 15 cm



Mast Steps stainless steel or plastic



The alternative way to the top!

Fixed Mast Steps in stainless steel

- Includes ring for the guide line
- Simple and strong construction
- V4A Stainless steel
- Well designed
- Blends in with the mast
- Universal fit
- Light weight

Folding Mast Steps in plastic

- Suitable to use in conjunction with the SWI-TEC mastlift instead of the masthead harness
- Reinforced plastic / nylon
- Easy to open and fold
- Does not rattle



ring for the guide line



Art. No.

1009

Maststep

Material:

stainless steel (V4A)

Fixings:

6 drill-holes

Sizes:

200 x 200 x 170 mm

Weight:

170 g

1068

Maststep foldable

GfK / Nylon

5 drill-holes

148 x 77 x 35 mm

164 g

2002

Rivets Monel

Monel

Clamping length 8 - 11 mm

Ø 4,8 x 16,5 mm



SWI-TEC Lifting aid for wheelchair users

Mast lift with special seat for wheelchair users

Getting on board from a wheelchair: Now it becomes easy and safe. The newly designed, faint-safe seat makes life easier for people with disabilities.

Now it becomes so easy and safe for wheelchair users or for persons who find the railing an unsurmountable obstacle to go on board or off board.

- Makes it easy and safe for people with disabilities to experience sailing
- Exclusive: We have a special lift system for use on board
- Smooth and safe transfer from the landing stage to the vessel
- No mast fittings required
- When required simply hook the unit on the main boom or mizzen boom
- Most versatile – also for man overboard maneuvers



Art. No. 5091 Chair for handicapped persons

Weight: 1,8 kg
max. load (person): 150 kg
Material: Cotton/polyamide mix
Polyester belts
Stainless steel cross-bar,
spring hook and rings
Including water resistant bag for stowing

The Mastlift Art. 1001 and 1002 is not included and must be ordered seperately.



Help Aboard

Hydro Charger

Now you can have enough power on board with our new Hydro Charger

Charge your batteries under sail by lowering the generator in the water

- Solid stainless steel construction (Aisi 316)
- Quick fastener device for mounting on transom bracket
- Foldable at full speed through 4x reduction ratio line
- Generator locks in working position, no tension on line (easy release means light pulling on the red line)
- Can be stored in fully inverted position (for ex. in harbour)
- Lateral stoppers to avoid generator hitting on transom
- 20 A / 12 V socket for watermaker, inverter 220 V / 50 Hz for charging cellular phones, TV, PC etc.
- Programmable converter charger with digital display
- Max. current programmable depending on battery capacity

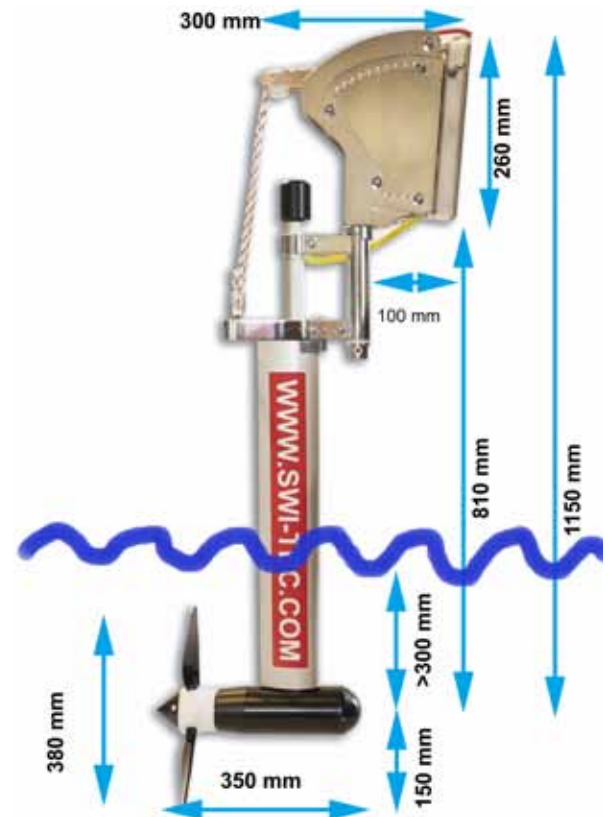

Hydro Charger

Art. No. 7147 (12V) 7148 (24V) with standard bracket

Art. No. 71471 (12V) 71481 (24V) with pivotable transom bracket

Size: 1100 x 100 mm Weight: ca. 18 kg



Attention!

For the use with lithium-ion battery

is it an absolutely muss, the installation of a breaker in the yellow AC cable, between generator and controller, which is commanded from the BMS (Battery Management System) of the battery.

This installation has to be approved from the battery producer.
Swi-Tec overtakes no responsibility for this installation.

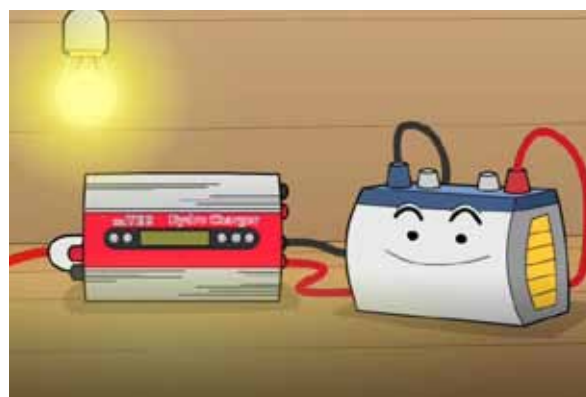

Included in the delivery



Generator

- Smooth running through custom-designed planetary gear
- Low ratio prevents high motor speeds
- Optimized efficiency through custom-designed transmission
- Double seals (2 O-rings each)
- Multiple-bearing propeller shaft
- Easy to remove and disassemble
- Hard anodized aluminium housing and synthetic cover.
- Streamlined anodized aluminium body
- All screws (A4) are additionally protected against corrosion by Duralac
- No propeller forces transmitted to the gearbox due to special coupling
- Almost inaudible in the water
- Charging from 4 knots upwards (depending on the pitch setting of the propeller blades)



Regulator

- Up to 16/32 volt adjustable, perfect to compensate voltage loss
- With built-in free wheel (propeller turns freely when the max. retained battery voltage is reached)
- Additional connection for solar panels or wind generator
- Additional connection for direct output, which will be automatically shut down when it has sufficient battery voltage
- **NEW:** integrated digital display
- **NEW:** additional switch for free wheel
- **NEW:** additional alarm when battery is completely charged
- **NEW:** more output



Propeller

- Main body manufactured in a solid synthetic material
- Stove enamelled aluminium propeller blades
- Blade angle is infinitely adjustable depending on type of the boat (speed)
- Propeller blades are replaceable (i.e. after collision)
- Blades CFD (software for numerical solutions) are designed specifically for generator with optimized form and twisting



Standard bracket or

- Including screws, nuts and security bolt
- Stainless steel bracket with middle section in plastic and counter plate



Pivotable transom bracket for the selection

- Including screws with a self-locking nut for achieve a slowly drop of the Hydro Charger
- With the pivotable transom bracket the Hydro Charger will always be in a vertical position in the water

Technical data

Mechanism to lift Stainless steel bracket with adjustable segment, folding-up with a line. Folding under speed is no problem, because there is a line reduction with 4x ratio. The generator is locked in position when deployed in the water. Quick fastener device for mounting on transom bracket.

Generator with Converter Charger without mounting bracket

Generator part: Gear drive with shaft, propeller and programmable converter charger with digital display and 4 m 3-core cable
Performance: Generates power from 4 knots (depending on boat speed and adjustment of the propeller blade pitch)
Output: 50 to 500 Watts depending on speed and battery load
Generator Dims.: Gear drive with shaft and bracket: 1100 x 100 mm, propeller diameter 360 mm

Charger:

Rated Power: 1.000W (Best ratio: Hydro Generator 600W, PV cells 400W)
Applicable batteries: 12V/24V from 200Ah/100Ah (voltage detected automatically)
Battery full charge cut: 16V/32V (adjustable)
Battery low voltage disconnect load: 11V / 22V
Load on voltage: 12,44V (default)
Load current max: 40A (20A at 24V)
No load loss: $\leq 45\text{mA}$
Dimensions: 278 x 133 x 75 mm
Weight: 1,6 kg
Working environment: Working temperature: -10-50°C Relative humidity: 0-90%
(no exterior installation, only inside the cabin)

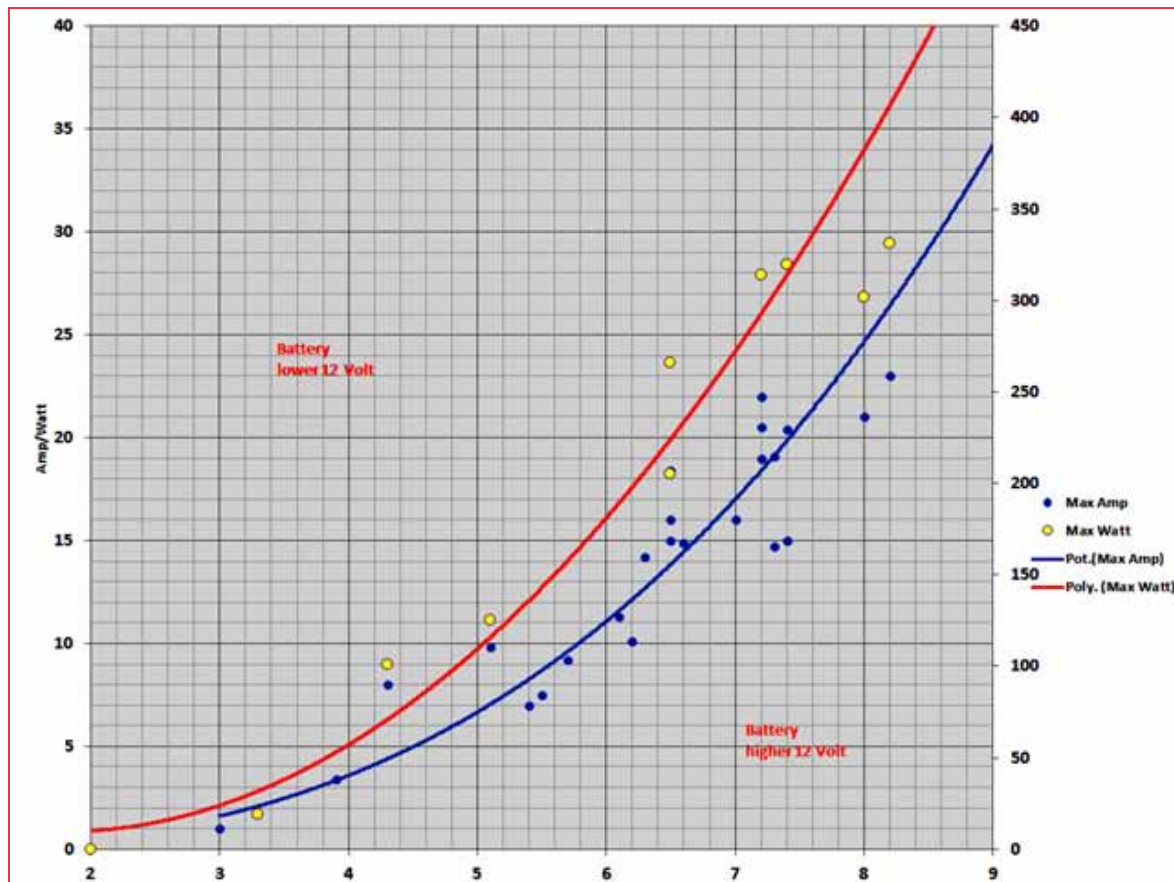

Accessories

Support for swim platforms

With our special support, you can attach the Hydro Charger to almost any platform.



| | |
|-----------------|-------------------|
| Art. No. | 7210 |
| Material: | Stainless steel |
| Size: | 265 x 70 x 260 mm |
| Weight: | ca. 2,4 kg |

Pivotable transom bracket Specifically for the sideways fitting



The Hydro Charger will always be in a vertical position in the water and therefore can achieve an optimal performance.
The holes are identical to the normal transom bracket and can be retrofitted with the normal bracket.
The swing resistance is adjustable using the self-locking nut. Thereby you achieve a slowly drop of the Hydro Charger.

| | |
|-----------------|------------------|
| Art. No. | 7149 |
| Material: | Stainless steel |
| Size: | 260 x 70 x 30 mm |
| Weight: | ca. 3,5 kg |



Standard bracket

Stainless steel bracket with middle section in plastic and counter plate
Including screws, nuts and security bolt

| | |
|-----------------|------------------|
| Art. No. | 7220 |
| Material: | Stainless steel |
| Size: | 260 x 70 x 30 mm |
| Weight: | ca. 2 kg |



Help Aboard

Universal Scarecrow

The new and versatile Scarecrow

The «Universal» scarecrow is composed of a base, 9 polyester rods with small balls at the ends, as well as a mounting flange. The flange is just 15 mm and can be permanently installed in any position with just 2 screws.

The unit is mounted by simply clipping and twisting through the bayonet-lock. Push down the safety bolt afterwards and the scarecrow is ready-to-use.

The polyester rods are individually replaceable and can be removed according to demand, i.e. single rods can be removed for mounting on individual swim platforms.



Art. No. 2100

Universal Scarecrow including bag

Material: Nylon, wires polyester
Size: L = 1,50 m
Diameter open: Ø ca. 2,7 m
Weight: 0,7 kg



Scarecrow Standard

At last the perfect Scarecrow! No more birds fouling your boat! (Guano)

- For sail or power boats
- No risk to birds
- Compact and easy to stow
- Stainless Steel construction (V4A), wires in polyester
- Can be used with SWI-TEC's universal accessories
- Easy to use, deploys and stows quickly

How to deploy:

Mount and secure the Scarecrow. Deploy the polyester wires by pulling the line and that's it!

The random movements of the wires and balls stop seagulls approaching. For larger boats you simply use additional Scarecrows.

To stow:

Pull on the other end of the line and the wires will disappear into the tube.

In the case that you wish to use the Scarecrow whilst your boat is covered with a canopy or tarpaulin, you will need to make a 25 mm hole in the material to insert the pole. The Art. No. 2084 is designed to stop water coming through that hole.

Art. No. 2070

Scarecrow Standard

Material: Stainless Steel V4A, polyester «wires»
Size: Length 1,60 m, tube diameter 25 mm, diameter of deployed scarecrow 2,70 m



Accessories for the Universal Scarecrow

Mount the support and secure the scarecrow. Then adjust the height you wish with the telescope.

For bigger boats you simply use an additional scarecrow. 3 loops give you the opportunity to secure the telescopic again, for this we recommend our mounting kit (Art. 2072)

In case you want to use the product while your boat is covered with a canopy or tarpaulin, you just have to make a 30 mm hole in the material an insert the tube with the additional SWI-TEC accessory.

| Art. No. 2111 | Support telescope |
|---------------|--|
| Material: | Stainless Steel V4A, |
| Size: | Extendable, Length 0,70 m - 1,3 m, tube diameter 25/30 mm |
| Weight: | 1,5 kg |



| Art. No. 2110 | Rail bracket |
|--|----------------------------|
| Material: | Nylon, Stainless steel V4A |
| Size: | Disc Ø = 80 mm |
| Weight: | 0,5 kg |
| The bracket can be screwed on the railing or handrails permanently or just temporarily. The flange with bayonet-lock is already fitted to the bracket. | |



| Art. No. 2105 | Canopy bracket |
|--|-------------------|
| Material: | Nylon, Plates PVC |
| Size: | 220 x 220 mm |
| Weight: | 0,3 kg |
| Many boats will be covered with a canopy when they are not in use. The canopy bracket will be delivered with the flange, 2 plastic plates and screws. In a suitable position cut 2 small holes in the canopy for the screws. The two plates are then attached to each other, one on each side. The plates with the flange remain permanently attached to the canopy. | |



| Art. No. 2102 | Extra support |
|---|----------------|
| Material: | Nylon |
| Size: | Disc Ø = 80 mm |
| The extra support for another installation of the Universal Scarecrow | |



Help Aboard

Accessories for the Scarecrow Universal and Standard

Art. No. 2081 Universal railing bracket

El soporte universal se puede utilizar para todos los objetos con una varilla de hasta Ø 32 mm.

El lado opuesto puede alcanzar una abertura de hasta 42 mm (redondo o cuadrado) y puede fijarse en cualquier posición hasta 360 °.



Art. No. 2072 Mounting kit

Material: Polyester straps and quick connections

Our mounting kit is suitable for the Scarecrow Standard or the telescopic bracket. The 3 polyester belts (4 m x 3 cm) with quick lock give a secure hold and you can enjoy life on board, free of bird droppings.



Art. No. 2085 Deck socket top-mount bushing

Art. No. 2086 Deck socket installation bushing

Material: Stainless Steel V4A

The base sleeve is perfect for making a steady attachment for the Scarecrow Standard or telescop of the universal Scarecrow. The sleeve is fastened with 4 screws and offers a secure stand.



Art. No. 2071 Mounting foot

Material: PVC / anodised aluminium

You would like to set up your Scarecrow Standard or do not have the option to attach it well on board. We have also developed the perfect solution for this with our adjustable foot. The integrated ball joint provides the necessary flexibility. In connection with our mounting kit item no. In 2072 they create an additional support.



Art. No. 2084 Cover for canopy

Material: PVC

Protect your ship from bird droppings even when it is covered
With our canopy cover made of PVC, you can use the telescopic for Scarecrow universal or the Scarecrow Standard even when the boat is covered.
The cover are supplied in blue and white. The tarpaulin measures 40 x 40 cm and can be used for all pipes and rods with a diameter of 25 mm or 30 mm.



Scarecrow for Mast Top

Protect your Mast top, arches etc. from seagulls

Newly developed scarecrow for the top of the mast. The rotating center section provides an even greater deterrent and the angle is adjustable.

The scarecrow is also useable on arches, cabin roofs and more.

| | |
|-----------------|---------------------------------------|
| Art. No. | 2091 |
| Model: | Mast top / Arch |
| Material: | PVC, Alu Anodised, polyester „wires» |
| Size: | H = 0,5 m, Ø ca. 1 m tube: Ø 22 mm |



Scarecrow for Spreaders (Set of 2)

Protection for your spreaders!

To protect your spreaders we developed the 50 cm long scarecrows. The end of the wires are encased in plastic to prevent damage to the sail. Check when using different sails!

| | |
|-----------------|----------------------------------|
| Art. No. | 2090 |
| Model: | Spreaders |
| Material: | PVC, polyester «wires» |
| Size: | L = 500 mm Delivery: Set of 2 |



Help Aboard

Outboard motor lift

The crane can be attached to the railing or railing stanchions!



More security and easy handling of your outboard engine!

- 4-power reduction
- Simple application
- Is only fixed with one just screw
- Delivered ready to use
- Double tube for more load capacity
- Long life thanks to stainless steel
- Also ideal for bringing your provisions aboard
- For vertical or horizontal railing diameters up to 30 mm

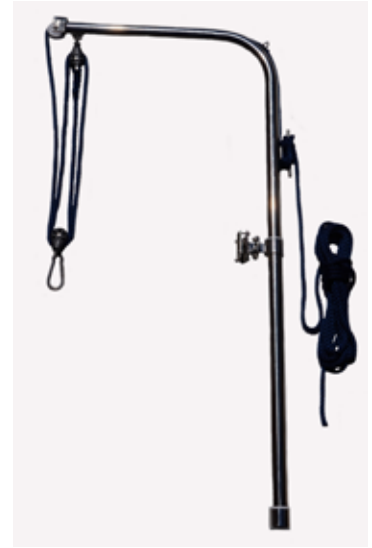

| | |
|-----------------|----------------------------|
| Art. No. | 5200 |
| Rope: | 15 m up to Ø 75 mm |
| Size: | 150 70 cm |
| Material: | Stainless steel (AISI 316) |
| Load capacity: | up to 100 kg |
| Weight: | 6,5 kg |



Thanks to the guide sleeves, the lift can be removed quickly when not in use.



Perfect in combination with



Lifting Harness for outboard-motors



The perfect solution!

- Carry the motor safely and comfortably
- Also for new outboard motors
- The lifting harness can remain attached



| | |
|-----------------|--------------------|
| Art. No. | 4042 |
| used for: | 2- to 4-HP-motors |
| Art. No. | 4045 |
| used for: | 4- to 20-HP-motors |

Material: 100 % polyester
Breaking Load: 100 kg



Rat Guards for ropes



Prevention is better than Cure!

- Rotating disc
- No more vermin on board
- Easy to use
- Very effective
- Compact
- May be used at anchor or in port
- Also usable for the anchor chain
- Replaceable rubber inserts

For the commercial shipping & super yachts

| | |
|-----------------|------------------|
| Art. No. | 1125 |
| Rope size: | up to Ø 75 mm |
| Size: | Ø 800 mm |
| Material: | PVC / Polystyrol |
| Weight: | 2,7 kg |

| | |
|-----------------|-----------------------|
| Art. No. | 1122 |
| Rope size: | from 15 mm to Ø 30 mm |
| Size: | Ø 360 mm |
| Material: | PVC / Polystyrol |
| Weight: | 500 g |

| | |
|-----------------|------------------|
| Art. No. | 1124 |
| Rope size: | up to Ø 45 mm |
| Size: | Ø 450 mm |
| Material: | PVC / Polystyrol |
| Weight: | 900 g |

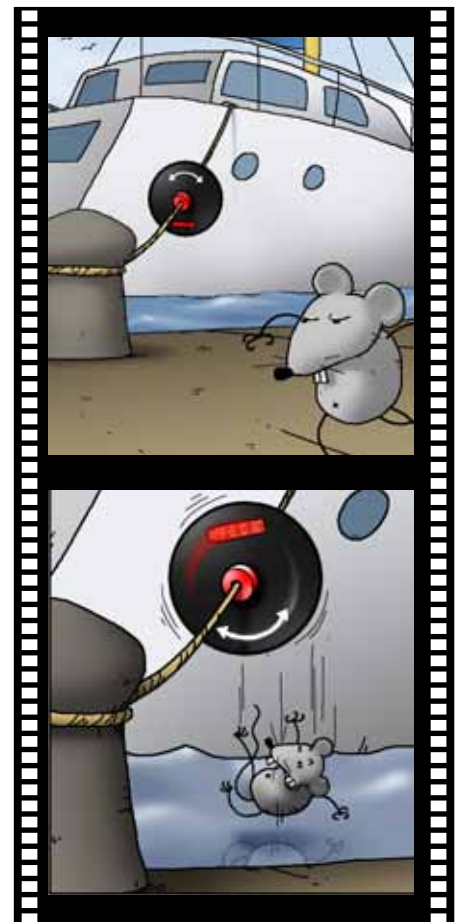

Help Aboard

Swing-Away Dinghy Stowage

The easy way to store your dinghy!

- Perfect for Motorboats and Sailboats
- With security bolt in 2 positions
- Easy to handle
- Adjustable to suit the hull of your dinghy (cutting required)
- Reinforcement plates provided
- Solid stainless steel with bronze bearing
- High load capacity



Art. No. 8030

with wood-support (wood cutting required)

Material: Stainless steel Aisi 316 /

Wood (African teak, iroko)

Parts: 2 pieces (right and left) incl. counter-plates,
2 straps and screws

Max. Load: 250 kg every bracket, weight: 24 kg each

Size: Length over all: 1080 mm
plates: 250 x 180 x 8 mm
length wood: 900 x 60 x 200 mm



Removable Dinghy Supports for platforms and decks

The easy and secure way to store your dinghy whilst under way.

Sockets and pad-eyes are attached to the swim platform or deck. The Plugs are attached to the wooden supports so that the dinghy can be stored securely using the straps and pad-eyes.

- Suitable for swim platforms and decks with space for one dinghy i.e. Jetski
- The platform remains free of clutter when dinghy is in the water, the wooden supports are only plugged into place when required.
- The wooden support can be cut to suit any boat profile (delivered as shown in picture).
- Delivered ready for mounting including pad-eyes and straps for securing the dinghy.

Art. No. 8028

The complete set

Material: Stainless Steel V4A / Wood (African teak/iroko)

Contents: 4 Sockets, 4 plugs with bolts, 4 Double
Pad-Eyes to secure, 2 Straps, two wooden
dinghy supports (cutting required), 40 screws

Weight: 4 kg

Size: Wooden Support: 600 x 50 x 100 mm
Sockets: Diameter Ø 40 mm, Depth: 50 mm,
Outside diameter sleeve Ø 15 mm



Fenderholder for stanchions

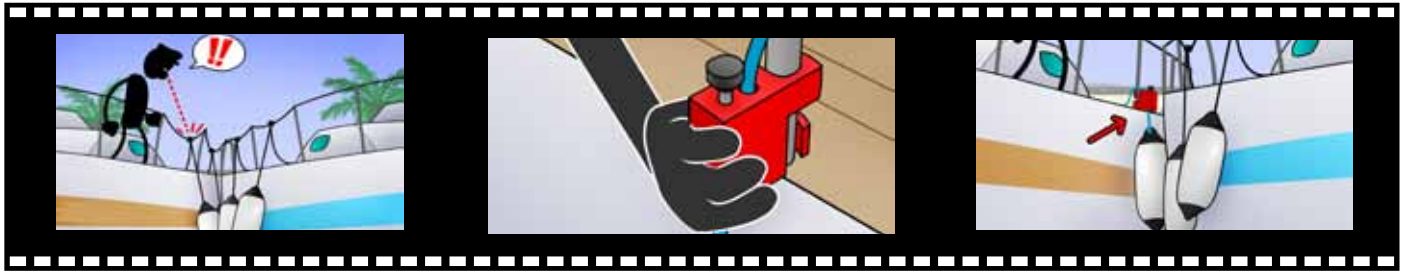

The perfect place to attach the fenders!

- Fast and easy to attach
- Easy to adjust the height
- The line stops by pressing on the black button
- No more high loads on the life lines
- Now you can use shorter fenderlines
- More attractive, because you don't have any more long lines on the guard rail
- Available for 3 different stanchion diameters: 23 mm (red), 25 mm and 30 mm
- Fender can remain permanently on the fenderholder
- By turning the holder 90°, take it off and stow it completely with fender in a locker
- A really nice gift
- Economically priced in a set of two
- With safety lock

Fenderholder in red (Set of 2)

| Art. No. | 2060 | 2061 | 2062 |
|------------------|-----------------------------------|-------|-------|
| for stanchion-Ø: | 23 mm | 25 mm | 30 mm |
| Colour: | red | red | red |
| Material: | Polyethylen / stainless steel 316 | | |
| Size: | from 6 mm up to 12 mm fenderlines | | |
| Weight: | 120 g (130 g) | | |

Fenderholder in blue (Set of 2)

| Art. No. | 20611 | 20621 |
|------------------|-----------------------------------|-------|
| for stanchion-Ø: | 25 mm | 30 mm |
| Colour: | blue | blue |
| Material: | Polyethylen / stainless steel 316 | |
| Size: | from 6 mm up to 12 mm fenderlines | |
| Weight: | 120 g (130 g) | |



Fenderholder in white (Set of 2)

| Art. No. | 20612 |
|------------------|-----------------------------------|
| for stanchion-Ø: | 25 mm |
| Colour: | white |
| Material: | Polyethylen / stainless steel 316 |
| Size: | from 6 mm up to 12 mm fenderlines |
| Weight: | 120 g (130 g) |



Specifications of Mould Resin



| Art. No. | 5040 |
|---|------------------------------|
| Heat-resistant: | up to 200° C |
| Compressive strength: | up to 800 kg/cm ² |
| Tensile strength: | up to 300 kg/cm ² |
| Easy to work, cures within 3 hours at 20°C. | |

Filling, repairing, fastening and shaping is no longer a problem with our universal Epoxy Putty.

Epoxy putty - repairs anything!

- Cures under water
- Used on all materials
- Cures within 3 hours

Can be used to repair or bond the following:

- Stone, wood, glass, plastic, metal, ceramic etc.
- Repairs both in and out of water
- Fills holes
- Repairs pipes or tanks
- Attaches screws, hooks and repairs stripped threads

Help Aboard

Shroud Clips

Use the shrouds... the space saving stowage solution!

Shroud clip for boathook

- Easy to install
- Boathook is always ready for action
- Velcro fastener included



Shroud clip with hook

- For anything that can be hung (can be used from Ø 4mm)
- For securing the gangway at the quarter-deck
- For attaching a tarpaulin or sun shade

Shroud clip for RopeFix

- Suitable for all ropes
- Ropes will dry easily
- Also suitable for a water-hose



| Art. No. | Stainless steel V4A |
|----------|---------------------------|
| 2042 | Shroud clip for boathooks |
| 2043 | Shroud clip for RopeFix |
| 2045 | Shroud clip with hook |

Sail Tie

The easiest and most practical way to wrap your sail!

- White webbing straps
- UV-resistant
- Washable
- No more springing bungee cord
- Secured with an adjustable clip buckle
- Quick and easy handling
- Individual fittings



| Art. No. | 5060 | 5070 | 5071 |
|--------------|----------------------|--------------|--------------|
| | Sail tie »S« | Sail tie »M« | Sail tie »L« |
| Boom length: | 2,5 – 4 m | 4 – 5 m | 5 – 6 m |
| Belts: | 4 | 5 | 6 |
| Colour: | white | white | white |
| Material: | 3 cm Polyester belts | | |

RopeFix - Lineholder (Set of 3)

No more messy lines!

- No more messy lines
- Easy to install
- Multi purpose

| Art. No. | 2051 |
|----------|-----------|
| Size: | Ø = 35 mm |
| Length: | 300 mm |
| Weight: | 15 g |



Chain Claw «Standard» and «Deluxe»

Protects your anchor winch and have a good night's sleep!

- Easy to use, with our boathook much easier «Deluxe»
- No more noise from the anchor chain
- The hook can also be released under strain
- Hook the chain and cleat off rope, the strain on the chain and winch is eliminated
- The Chain Claw acts as a shock absorber
- With 5 meter spliced line
- The hook can also be released under strain together with the tripping line («Deluxe»)



Model «Deluxe»

- Can be released from board with the hole line.
- Easier hanging on the chain with our special boat hook



To be used in conjunction with a SWI-TEC telescopic boat hook, adaptor or boat hook tip (P.33).



Chain Claw for Catamaran «Standard» and «Deluxe»

- As above but with 2 spliced lines, each of 6 m
- Available for 8 - 13 mm chain

Standard



Deluxe



Now also available for Superyachts



| | Superyacht | | | Superyacht | Superyacht | Catamaran | Catamaran | Catamaran |
|----------------|------------|----------|----------|------------|------------|-----------|--------------|--------------|
| for Chain: | 6/8 mm | 10 mm | 12/13 mm | 10 - 16 mm | 18 - 22 mm | 8 mm | 10 mm | 12/13 mm |
| Max. Load: | 1000 kg | 1200 kg | 1600 kg | 3500 kg | 4500 kg | 1200 kg | 1200 kg | 1200 kg |
| Weight: | 0,6 kg | 0,6 kg | 0,6 kg | 0,8 kg | 1,4 kg | 0,8 kg | 0,8 kg | 0,8 kg |
| Size length: | 120 mm | 120 mm | 120 mm | 220 mm | 250 mm | 120 mm | 120 mm | 120 mm |
| Line spliced: | 5 m line | 5 m line | 5 m line | | | 2x6m line | 2 x 6 m line | 2 x 6 m line |
| Size / line: | Ø 12 mm | Ø 14 mm | Ø 14 mm | | | Ø 12 mm | Ø 14 mm | Ø 14 mm |
| «Standard» | 1028 | 1029 | 1038 | | | 10282 | 10292 | 10382 |
| «Deluxe» | 10283 | 10293 | 10383 | | | 10284 | 10294 | 10384 |
| «without line» | 10281 | 10291 | 10381 | 1041 | 1070 | 10281 | 10291 | 10381 |



Anchoring

Self-Adjusting Anchor Buoy

The Original

Lifting ring to pick up the buoy

Stainless steel (V4A)

SOLAS reflective safety tape to make the buoy visible for everyone in the dark

Specially designed self-rolling strap mechanism

Edge protection for optimum security

Solid but light weight plastic body



Belt with strength up to 1100 Ibs (500 kg)

belt length up to 20 m
Line extension with 10 m belt possible

Video Demo
www.swi-tec.com



Mark your anchor with the «ORIGINAL» SWI-TEC Anchor Buoy!



- Often copied but never matched the quality
- More than 25 years on the market!
- To a maximum water depth of 65 feet
- The buoy is always positioned directly above the anchor
- Unique, specially designed self-rolling belt/strap mechanism
- No complicated calculations for guessing the length of line let out
- Tripping the anchor is easy
- A tensile strength of up to 1100 Ibs
- Precisely marks the anchor's set position
- Safety reflector (3M)
- Can function as a tripping line

New: line extension for Anchor Buoy

| Art. No. | 1020 | 1027 Line extension |
|-------------------|------------------------------------|---------------------|
| Size: | Ø = 300 mm, H = 420 mm | |
| Lenght: | 20 m webbed belt | 10 m webbed belt |
| Weight: | 3,5 kg | |
| Strength of belt: | 500 kg | |
| Material: | High impact plastic; Stainl. steel | |



Buoy Rack



Your anchor buoy is always ready to use!

- Has been designed especially for the SWI-TEC anchor buoy in stainless steel
- Double spring security clips
- Can be easily attached to the pulpit rails
- Adjustable angle
- **Ideal:** Support can also be mounted in the anchor locker



| Art. No. | 1021 |
|-----------|-----------------------|
| Size: | Ø = 350 mm, H= 130 mm |
| Rail: | Ø = 18 – 30 mm |
| Weight: | 0,7 kg |
| Material: | stainless steel (V4A) |

Just leave the 2 back parts of the clips and the support can be easily mounted

Anchoring

Anchor Buoy Light

Flashing Light for your anchor buoy!

- Automatic on/off due to twilight switch
- Turn off if not used tuning the cap
- LED Blinking
- Power Save
- Water resistant
- Range of sight 1 nm approx.
- Retrofit for all SWI-TEC Anchor buoys
- Including 2x AA batteries



| | |
|-----------------|-------------------------|
| Art. No. | 1014 |
| Size: | Ø = 40 mm, H = 200 mm |
| Weight: | 200 g |
| Interval: | Approx. 40 Flash / min. |
| Range: | Approx. 1 Nm |
| Material: | Plastic |



Boat name lettering, prohibited anchoring decal

Mark your anchor buoy!

- The decals forbidden anchor decal prevents mooring by mistake
- Your own ship name makes it less likely that the buoy is used or stolen



Art. No. 1022
Boat Name Lettering

Art. No. 2041
Prohibited Anchoring Decal

Chain for Mooring Buoys

No more chafed lines on Mooring Buoys

- Pass your mooring line through the ring, cross the lines and attach it to your cleats
- Easy handling
- High quality stainless steel chain
- Best quality ropes (Liros)
- 3 different versions for boats up to 10 m / 15 m / 20 m



| Art. No. | 1220 | 1221 | 1222 |
|---------------------------|---------------|---------------|---------------|
| Length of the boat: | up to 10 m | up to 15 m | up to 20 m |
| Chain stainless steel: | 1,4404 | 1,4404 | 1,4404 |
| Measure of the chain: | Ø 8 mm | Ø 10 mm | Ø 10 mm |
| Diameter of the rope: | Ø 14 mm | Ø 18 mm | Ø 22 mm |
| Material: | Polyester PES | Polyester PES | Polyester PES |
| Length of chain and rope: | 1 m + 2 x 5 m | 1 m + 2 x 6 m | 1 m + 2 x 6 m |
| Breaking load: | 3600 kg | 6000 kg | 9000 kg |

Stabilizer

Anchor comfortably, without rocking!

- Dampens the roll from waves by up to 50 %
- Easy to use
- Supplied individually, (see table below)
- Foldable
- Compact storage bag included
- To be attached at the bow or on the side

| Weight in tons | 5 | | 10 | | 15 | | 20 | | 25 | |
|---------------------------------------|-----|------|------|------|-------|------|-------|-------|-------|------|
| Reduction of the movement of the boat | 50% | -30% | -50% | -30% | -50% | -30% | -50% | -30% | -50% | -50% |
| Number of recommended Stabilizers | 1 | 1 | 2 | 2 | 2 - 3 | 2 | 2 - 4 | 2 - 3 | 3 - 5 | |

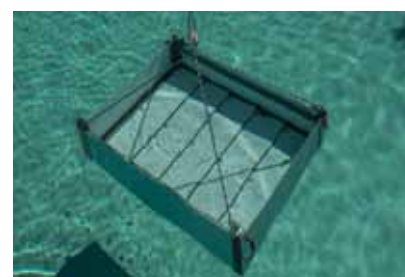

| Art. No. | 1085 |
|-------------------|------------------------|
| Stabilizer: | big, Inox V4A |
| Size: | 450 x 600 x 190 mm |
| Size when folded: | 450 x 600 x 60 mm |
| Weight: | 8,2 kg |
| Delivery: | each stabilizer in bag |



Tip:
We recommend to fit the stabilizers on the same side!



Anchoring

Stainless Steel Chain and Chain Marker

CROMOX®

The perfect Combination

The **Stainless Steel chain** is the third component in this truly unique Ground Tackle System.

The tensile strength is significantly higher than galvanized steel chain and the polished stainless steel surface has a self-cleaning effect which allows the smooth running of the chain. Technical specifications are listed in the price sheet.

Due to a higher PREN-value we suggest the anchor chain DUPLEX for warmer water like the Mediterranean or Carribean.

Our prices are incl. electropolishing!

Please find the current price list on our website www.swi-tec.com. Minimum order 15 meters

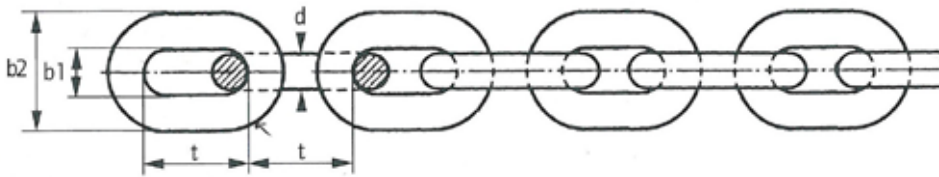

Technical data anchor chain

AISI 316L, measures acc. to DIN 766, tested, calibrated, bright polished (also available in ISO 4565)

| Art. No. | Dimensions mm | | | | Weight kg | Safe Working Load kN | Breaking Force kN |
|----------|---------------|------|---------|---------|--------------|----------------------------|-------------------------|
| | d | t | b1 min. | b2 max. | | | |
| 8022 | 6 | 18,5 | 7,2 | 20,8 | 0,780 | 18,75 | 37,5 |
| 8023 | 8 | 24,0 | 9,6 | 27,2 | 1,350 | 31,50 | 63,0 |
| 8024 | 10 | 28,0 | 12,0 | 36,0 | 2,300 | 50,00 | 100,0 |
| 8025 | 13 | 36,0 | 15,6 | 47,0 | 3,900 | 83,50 | 167,0 |

Technical data anchor chain DUPLEX

AISI 318LN Duplex, measures acc. to DIN 766, tested, calibrated, bright polished (also available in ISO 45)

| Art. No. | Dimensions mm | | | | Weight kg | Safe Working Load kN | Breaking Force kN |
|----------|---------------|------|---------|---------|--------------|----------------------------|-------------------------|
| | d | t | b1 min. | b2 max. | | | |
| 80221 | 6 | 18,5 | 7,2 | 20,8 | 0,780 | 19,25 | 38,5 |
| 80231 | 8 | 24,0 | 9,6 | 27,2 | 1,350 | 33,00 | 66,0 |
| 80241 | 10 | 28,0 | 12,0 | 36,0 | 2,250 | 52,00 | 104,0 |
| 80251 | 13 | 36,0 | 15,6 | 47,0 | 3,900 | 88,50 | 177,0 |



Chain markers

These little helpers will mark your anchor chain easily!

- Are easy to clip inside the chain
- Are available in five different colours
- Easy to find out how much chain has been used

| Colour | 8 mm (10 pc.) | 10 mm (8 pc.) | 12 mm (8 pc.) |
|--------|------------------|------------------|------------------|
| | Art. No. | Art. No. | Art. No. |
| red | 8007 | 8008 | 8009 |
| blue | 80071 | 80081 | 80091 |
| green | 80072 | 80082 | 80092 |
| yellow | 80073 | 80083 | 80093 |
| white | 80074 | 80084 | 80094 |

The Perfect Combination

ORIGINAL Anchor and Anchor Connector

Since its introduction and patenting this **anchor** has been in service world-wide under extreme conditions and has proven to be a super all-purpose anchor:

The ability to set quickly and hold in the most difficult grounds such as mud, clay shale, gravel, rock and seaweed is the principle benefit of this truly universal anchor.

After stringent tests the German Lloyd's issued the certificate: «Anchor with high holding ability».

The **Powerball** is the perfect anchor-to-chain connector. The full swivel ball and socket design permits the rotation around its own axis and swivels up to 30° in all directions. It is considerably stronger than the matching chain and is also certified by German Lloyd's.



THE ORIGINAL

Please find the current price list on our website www.swi-tec.com



Bracket Anchor

| Art. No. | Weight |
|----------|--------|
| 8013 | 14 kg |
| 8014 | 18 kg |
| 8015 | 25 kg |
| 8016 | 30 kg |
| 8017 | 42 kg |



Anchor Connector -Powerball

| Art. No. | Chain | Anchor weight |
|----------|------------|---------------|
| 8000 | 6 mm | 6 – 11 kg |
| 8001 | 8 mm | 18 – 25 kg |
| 8002 | 10 mm | 18 – 30 kg |
| 8003 | 10 – 13 mm | > 30 kg |
| 8004 | 13 mm | 42 – 52 kg |
| 8005 | 16 mm | 52 – 60 kg |
| 8019 | 20 mm | > 60 kg |



Burglar-lock

Burglar-lock for anchor and Powerball

- Anchor and Powerball are secured against theft
- The solid designed as stainless steel lock (V4A) can be fixed quickly, easily and effortlessly as a lock between anchor and connector

| Art. No. | 8020 |
|----------|---|
| | for anchor and Powerball, stainless steel |

Mooring

Mooring Buoy and Retrieving Hook

To attach a buoy quickly, easy and safely!

- Two hooks in one
- Easy release from moorings (trip line included)
- Easy tying up in locks
- Simply clip on to the ring of the buoy and cleat off the line on board
- By tightening the screw you can retrieve the anchor buoy or other items that may have fallen over board
- Both sizes include 10 m spliced lines
- Available in two sizes

To be used in conjunction with a SWI-TEC telescopic boat hook, adaptor or boat hook tip.



Tip:
Up to 8 tons you should chose the standard size.
More than 8 tons we recommend the heavy-duty version.



Important: Don't use it for permanent tie-up!

| Art. No. | 1031 Standard | 1034 Strong |
|-------------------|---|---|
| Permissible Load: | 1200 kg | 3500 kg |
| Supplied with: | 10 m line, Ø 12 mm 10 m line, Ø 4 mm | 10 m line, Ø 14 mm 10 m line, Ø 4 mm |
| Size: | 110 x 190 mm | 120x200 mm |
| Weight: | 1 kg | 1,5 kg |
| Material: | stainless steel Ø 10 mm | stainless steel Ø 14 mm |



Boat Hook and Accessory Adaptors

A heavy telescopic boat hook with nylon hook and accessory adaptor!

- The telescopic boat hook - adjusts from 1,17m - 1,96m
- Compatible with all SWI-TEC accessories
- Boat hook tip for up to 25mm pipe to convert existing hook to take SWI-TEC accessories
- Plastic boat hook adaptor to convert existing hook to take SWI-TEC accessories (1 up to 25 or 30 mm diameter pipe)
- Adaptor with counter plate 25mm
- Including Screws



Adaptor to remove
(for charter) to bolt down with counter plate with screws and nuts.



Tip:
Regularly clean your telescopic boat hook with fresh water.

| Art. No. | 2031 Telescopic boat hook | 2022 Boat hook tip | 1033 Plastic adaptor | 5072 Plastic adaptor | 5050 Plastic adaptor with counter plate |
|------------|---------------------------------|-----------------------|-------------------------|-------------------------|---|
| Size: | 1,17 - 1,96 m | Ø = 25 mm | Ø = 25 mm | Ø = 30 mm | Ø = 25 mm |
| Material: | Aluminium anodized | Nylon | Nylon | Nylon | Nylon |
| Delivery : | | | incl. screws | incl. screws | |

Anchor Clearing Hook

Multi-purpose anchor clearing hook...

- Makes it easy to free your anchor if somebody has dropped an anchor line over your anchor chain
- Also can be used as flood hook
- Retrieve your anchor as far as possible
- Includes 3 m spliced lines

Release with the red line remotely.

To be used in conjunction with a SWI-TEC telescopic boat hook, adaptor or boat hook tip.

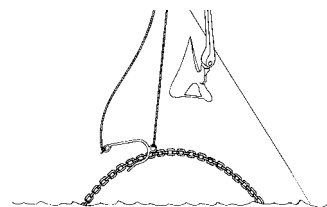
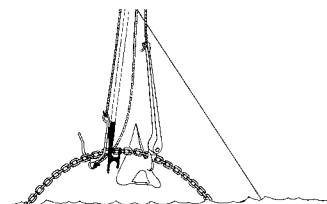

| Art. No. | 1032 |
|----------------|--------------------------------|
| Load: | 1000 kg |
| Supplied with: | 2 x 3 m spliced line Ø = 10 mm |
| Size: | 140 x 280 mm |
| Weight: | 0,8 kg |
| Material: | Stainl. steel (V4A), Ø 12 mm |



Mooring

Line Hook for Lazy-lines

With this hook docking in a harbour is child's play!
The quickest, easiest and cleanest way to moor!

To use:

1. Line hook is attached to the Boat hook, reach down or out and snap it over the lazy-line.
2. Then remove the Boat hook and let the Mooring line hook sink to the bottom, holding the lead line, which remains attached to the Mooring line hook and walk to the bow of the boat.
3. Lift the Mooring line and cleat it down.
4. Mooring can't be done more easily or quickly.

To be used in conjunction with a SWI-TEC telescopic boat hook, adaptor or boat hook tip.

- No more barnacle cuts
- No more dirty clothes
- No more dirty deck
- 5 m spliced line

| | |
|-----------------|-----------------------|
| Art. No. | 1030 |
| Material: | Stainless steel (V4A) |
| Load: | 500 kg |
| Supplied with: | 5 m line, Ø 10 mm |
| Size: | 160 x 260 mm |
| Weight: | 0,8 kg |

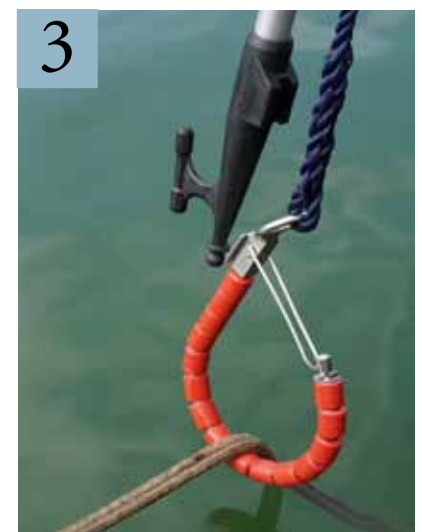
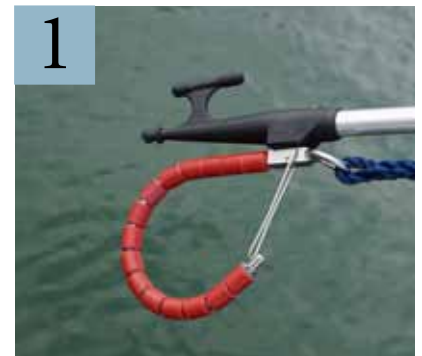
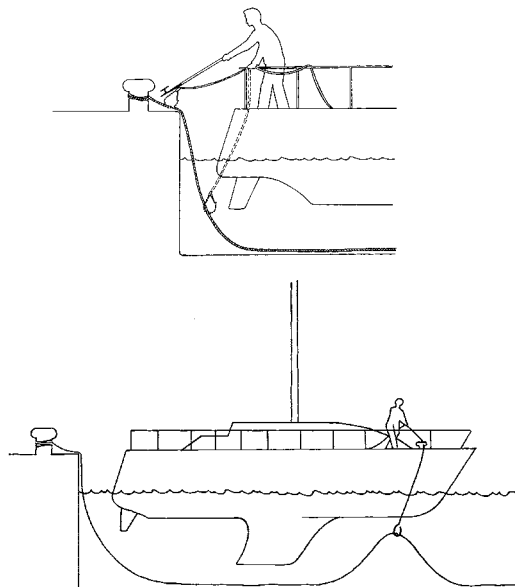

Safety Lock



Easy attaching to bollards, cleats, posts, and locks.

- Perfect to use on sluices and locks
- Multi purpose
- Length of wire rope 1200 mm
- Moor up without leaving the boat
- Release remotely
- 5 m spliced line
- Including a security catch to eliminate accidental release



| Art. No. | 1036 | 1037 |
|----------------|--|---------|
| Safety Lock: | 1200 mm | 1500 mm |
| Material: | High impact plastic, aluminium and stainless steel (V4A) | |
| Load: | 1000 kg | |
| Weight: | 1,2 kg | |
| Supplied with: | 5 m, Ø 12 mm; 5m, Ø 4 mm - polyester rope | |
| Size: | 60 x 30 x 120 mm | |



To be used in conjunction with a SWI-TEC telescopic boat hook, adaptor or boat hook tip.



Video Demo
www.swi-tec.com



Mooring line tensioner



For secure mooring in Mediterranean ports!

- Easy to pull the mooring line through
- Stay on board to release
- Quick to attach
- For mooring lines from 12 mm through 25 mm

How to use:

1. To tension open the cover and insert the mooring line
2. Under force the mooring line is jammed, you can haul it through by hand or by a winch
3. It is easy to attach a new mooring line
4. Pull the red line to release the mooring line tensioner

Video Demo
www.swi-tec.com



| Art. No. | 1130 |
|----------------|--------------------------------------|
| Material: | polyethylene and stainless steel V4A |
| Size: | 130 x 100 x 40 mm |
| Weight: | 1,4 kg |
| Pulling lines: | Ø 12 mm, length 5 m |
| Mooring lines: | Ø = 12 - 25 mm |
| Max. Load: | 300 kg |



Sun Awning Kit with telescopic tube

Our sun sail system is suitable for motor and sail boats!



Shade on board with our awning system

Many boats have no sun protection and you are at the mercy of the sun, even in the harbor or anchoring at the sea. We all would seek for some shade!

Even if the boats are equipped with a bimini, the same applies to the rear bench seat, or sun lounge at the bow. As the sun's rays become more and more aggressive, sun protection is absolutely important.

With our flexible system we have the solution for all common sport boats and sailboats. The telescopic tube offers 6 different adjustment options and can be extended up to 190 cm.

We offer the sun sail system for boats with or without railing and also the sun sail in white or blue.

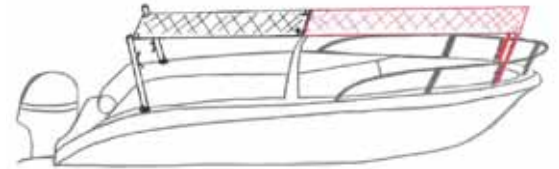

Sun Awning Kit(without awning)

| Art. No. | 5300 | 5301 | 5302 | 5305 | 5310 |
|------------|--|-------------|-------------|----------------------|----------------------------|
| Stanchion: | for Ø 22 mm | for Ø 25 mm | for Ø 30 mm | Deck socket vertical | Deck socket inclined (60°) |
| Content: | 2 telescopic stainless steel tubes (Ø 25mm / length 110 cm - 190 cm) with line, cleat and carabiner. | | | | |
| Material: | Stainless steelV4A | | | | |

Awning made to measure (pro m²)

| Art. No. | 5340 | 5341 |
|-----------|-------------------|------|
| Colour: | white | blue |
| Material: | Cotton-poly blend | |



Wind Scoop

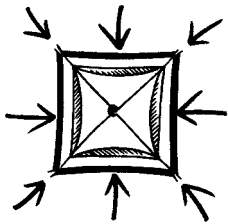

Optimal air circulation from all directions!

The ideal solution in port and at anchor!

- No need to reposition the scoop to face the wind
- The four-chamber system is always drawing air
- Very compact when stowed (incl. bag)
- Special low-noise fabric
- UV-resistant fabric

Tip:

Install a bungee between halyard and windbag to catch the wind scoop.

> Special Mosquito-net for wind scoop available

Easy installation of the wind scoop is guaranteed by using our famous Tenax pull-up fasteners. (Optional set of four available)



Wind Scoop

| Art. No. | 1010 | 1011 |
|-------------|-----------------------------|--------------|
| Hatch size: | 500 x 500 mm | 700 x 700 mm |
| Material: | Nylon textile, UV-resistant | |

Tenax Pull-up Fastener

| Art. No. | 2010 | 2011 |
|-----------|---------------------|------|
| Sets: | 1 | 4 |
| Material: | Brass chrome plated | |



Mosquito-net

No more troublesome flies and mosquitos on board!!

- Easy installation
- The lead-filled beading ensures a close fit
- Fine polyester netting
- Raindrops run off

> Also available for our Wind Scoop

Tip:

Chose mosquito-net one size bigger than your hatch size!



| Art. No. | 1091 | 1093 | 1094 | 1098 |
|-----------|---|--------------|--------------|--------------------------------------|
| Size: | 540 x 540 mm | 620 x 620 mm | 700 x 700 mm | for Wind Scoop Art. No. 1010/1011 |
| Material: | Special fine polyester web with lead inlays | | | |



FixTop - Sun Shade

Further development of our well-tried Sun Shade!

- Rain or Sun protection
- «Multitex» fabric
- Optional mounting kit - 6x white straps (3m x 3cm)
- Compact design
- Available in two sizes
- Available white or blue
- UV-stable fabric
- Ideal for either sail or motor boats
- Installed quickly and easily
- Stretchable fabric
- With mounting stand it can be used as sun shade



«Standard»

| Art. No. | 5074 | 5076 |
|-----------|---------------------|----------------|
| Size: | 1900 x 2300 mm | 1900 x 2300 mm |
| Colour: | white | blue |
| Material: | alum. anodised | |
| Textile: | Multitex | |
| Volume: | 1250 x 120 x 120 mm | |
| Weight: | ca. 2 kg | |

«Special»

| Art. No. | 5075 | 5077 |
|-----------|---------------------|----------------|
| Size: | 2500 x 3000 mm | 2500 x 3000 mm |
| Colour: | white | blue |
| Material: | Aluminium eloxiert | |
| Textile: | Multitex | |
| Volume: | 1550 x 120 x 120 mm | |
| Weight: | ca. 3 kg | |

Accessories

| Art. No. | 5078 |
|--|------|
| Mounting kit for FixTop, all sizes, 6x white straps (3m x 3cm) | |
| Art. No. | 5079 |
| Feet, anodized aluminium (1,2 – 2 m) | |



RollTop - simple roll-out system

The Ultimate Sun Protector!

- Quick installation
- Wide range of applications
- Just pull out and secure
- Up to 1,9 m long
- Ideal for either sail or motor boats
- Waterproof UV-stable fabric- come rain or shine
- Different mounting options (Fastening with a belt / Attachment with bracket / Wall mounting) the accessories are included

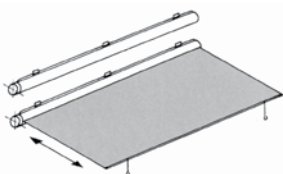

| Art. No. | 5088 |
|---------------|---------|
| Colour: | white |
| Length: | 1700 mm |
| Total length: | 1900 mm |
| Diameter: | Ø 40 mm |
| Weight: | 2 kg |



Winch Cover (Set of 2)



Protect your winches against moisture and dirt!

- Ideal protection for winches
- Easy to install
- Available in white or blue
- Available in XL!



| Art. No. | Colour | Size | Winch Diameter | Height |
|----------|--------|------|----------------|--------|
| 1045 | blue | S | 80 – 140 mm | 18 cm |
| 1049 | white | S | 80 – 140 mm | 18 cm |
| 1046 | blue | M | 140 – 200 mm | 25 cm |
| 1051 | white | M | 140 – 200 mm | 25 cm |
| 1047 | blue | L | 200 – 250 mm | 33 cm |
| 1053 | white | L | 200 – 250 mm | 33 cm |
| 1054 | blue | XL | 240 – 320 mm | 36 cm |
| 1055 | white | XL | 240 – 320 mm | 36 cm |

Material: Acryl with UV resistant coating
Washable at 40 °C



Turnbuckle Cover (Set of 2)



No more torn sails and no more injuries caused by loose shroud tensioners!

- New design
- Split design for easy installation
- No re-rigging or / adjustment
- Quick to install
- Durable UV stable fabric
- Easy to clean



| Art. No. | 6010 | 6011 | 6012 | 6013 |
|-----------|---|--------|--------|--------|
| Length: | 300 mm | 400 mm | 500 mm | 600 mm |
| Material: | PVC, special UV-resistant, 40° C washable | | | |



Burglar Bars for Hatches



Burglar Bars for hatches – day or night!

- No more stale air, when you return on board
- Easy to use
- Works with wide range of hatch shapes
- Solide stainless steel construction (V4A)
- Can be used in conjunction with Windbag or Mosquito-net
- Available in three sizes
- Including waterproof storage bag



Video Demo
www.swi-tec.com



Accessories

| Art. No. | 1110 | 1111 | 1112 |
|----------------|---------------------|--------------|--------------|
| Size of hatch: | 300 – 450 mm | 450 – 550 mm | 600 – 700 mm |
| Material: | Stainless steel V4A | | |

| Art. No. | 1115 |
|----------|-------------------|
| | Stainless padlock |



Installation height of the hatch burglar protection system: max. 130 mm

SWI-TEC Emergency Ladder



Safety on board! New Model!

- Releasable from the water
- Usable as everyday boarding ladder
- Adjustable height
- Fits to any rail
- Length 2,5 m (steps are under water, too)
- 7 strong steps of GFK
- Compact design
- With handles on both sides



Art. No. 6005

Model with handles

| | |
|-----------|---|
| Size: | 500 x 300 mm |
| Length: | 2,5 m |
| Weight: | 2.7 kg |
| Steps: | 7 units, 40 cm long |
| Material: | Nylon, webbed belt polyester, steps polyester |

Sailboat-Burglar Lock «Standard»

Secure your boat against break-ins while you are out!

- Solid stainless steel construction (V4A)
- D.I.Y. installation
- Universal fitting for all sailboats
- Easy to use: just fit the bolt and close

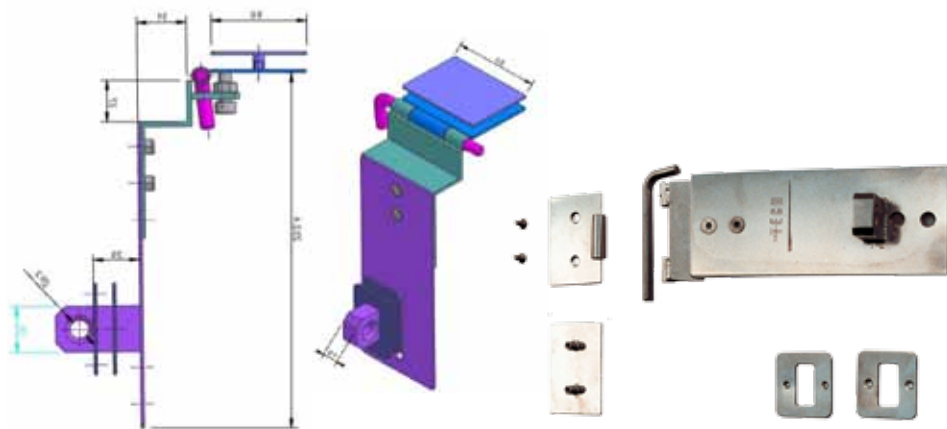

| | |
|-----------|--|
| Art. No. | 1042 |
| Size: | 60 x 80 mm (coverplate) 240 x 80 mm (lockplate) |
| Weight: | 950 g |
| Material: | 2 mm stainless steel (V4A) |



Sailboat-Burglar Lock «Deluxe»

Further development!

Secure the companionway from inside!

- Developed from the basic Sailboat Burglar Lock
- Allows locking from inside and outside

| | |
|-----------|--|
| Art. No. | 1043 |
| Size: | 60 x 80 mm (coverplate) 240 x 80 mm (lockplate) |
| Weight: | 950 g |
| Material: | 2 mm stainless steel (V4A) with inside fastener |

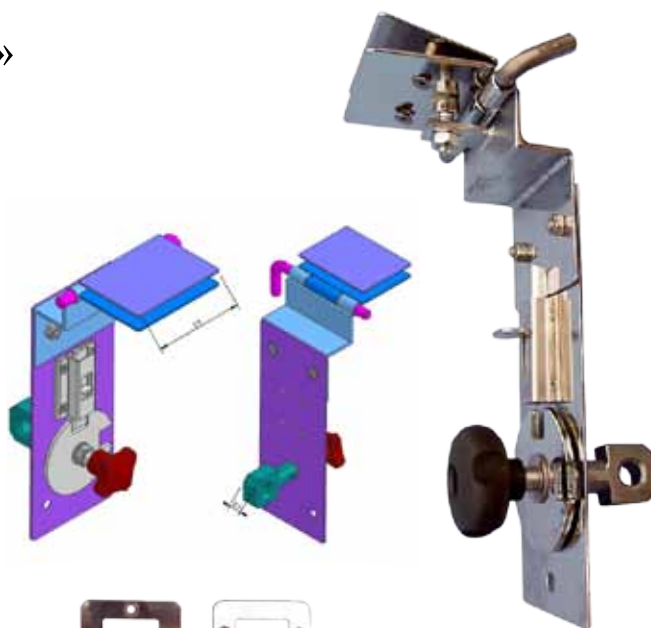

Accessories

| | |
|----------|------------------------|
| Art. No. | 2040 |
| | Rustless security lock |

Gangways 3x folding



New-Mini (Art. No. 8072)



Classic (Art. No. 8066)



Light (Art. No. 8061, 8062)

The railing of the Light and Classic models is located on the left side when going up.
Changes on request.

All Gangways are delivered with supports and wheels.



Custom made
Custom sizes built to order!



Gangways 2x folding



Light and Classic
(Art. No. 8045, 8046, 8051, 8052, 8047, 8053)



New-Mini (Art No. 8070)



Gangways that are strong yet light!

- A wide variety of models
- «Mini» model for small boats
- «Light» model for bigger loads up to 150 kg with supports
- «Light» & «Classic» models offer increased strength and durability, Teak finish available
- Non-slip surface
- Includes stainless steel deck socket for onboard installation
- Made of marine grade aluminium and stainless steel
- Available in 1x or 2x folding versions
- Length 2 m, 2,5 m or 3 m
- Custom sizes built to order
- Separate deck sockets available on request
- Pin diameter (New-Mini = Ø 20mm
Light & Classic = Ø 30 mm)

**Now all the gangways also available with
3 folding sections!**



| Art. No. | Name | folding selections | Material | Length | Width | Weight | max. Load | Height* | Length* |
|----------|------------|--------------------|----------------|--------|-------|---------|------------|---------|---------|
| 8070 | «New-Mini» | 2 | Aluminium | 2 m | 28 cm | 8 kg | ca. 120 kg | 10,5 cm | 1,10 m |
| 8072 | «New-Mini» | 3 | Aluminium | 2 m | 28 cm | 8 kg | ca. 120 kg | 16 cm | 0,74 m |
| 8045 | «Light» | 2 | Aluminium | 2 m | 32 cm | 11 kg | ca. 120 kg | 12 cm | 1,11 m |
| 8046 | «Light» | 2 | Aluminium | 2,5 m | 32 cm | 13 kg | ca. 120 kg | 12 cm | 1,31 m |
| 8051 | «Light» | 2 | Teak-Aluminium | 2 m | 32 cm | 13 kg | ca. 120 kg | 12 cm | 1,11 m |
| 8052 | «Light» | 2 | Teak-Aluminium | 2,5 m | 32 cm | 15 kg | ca. 120 kg | 12 cm | 1,31 m |
| 8061 | «Light» | 3 | Aluminium | 2 m | 32 cm | 12.5 kg | ca. 120 kg | 18 cm | 0,77 m |
| 8062 | «Light» | 3 | Aluminium | 2,5 m | 32 cm | 14.5 kg | ca. 120 kg | 18 cm | 1,01 m |
| 8063 | «Light» | 3 | Teak-Aluminium | 2 m | 32 cm | 13.5 kg | ca. 120 kg | 18 cm | 0,77 m |
| 8064 | «Light» | 3 | Teak-Aluminium | 2,5 m | 32 cm | 15.5 kg | ca. 120 kg | 18 cm | 1,01 m |
| 8047 | «Classic» | 2 | Aluminium | 3 m | 44 cm | 22 kg | ca. 150 kg | 14 cm | 1,60 m |
| 8053 | «Classic» | 2 | Teak-Aluminium | 3 m | 34 cm | 25 kg | ca. 150 kg | 14 cm | 1,60 m |
| 8066 | «Classic» | 3 | Aluminium | 3 m | 44 cm | 22 kg | ca. 150 kg | 21 cm | 1,18 m |
| 8065 | «Classic» | 3 | Teak-Aluminium | 3 m | 34 cm | 25 kg | ca. 150 kg | 21 cm | 1,18 m |

* when folded

Gangways Accessoires: Non-slip mat for gangway



Advantages

- Allow elderly people a safe walk over the gangway
- Bring small children to the deck without danger or accidents
- Safe grip in wet conditions
- Simple assembly and disassembly
- Available for ALL gangways
- UV and ozone resistant
- Resistant to wind and weather
- Hard-wearing and tear-resistant
- Relieves legs and joints
- Dimensionally stable and abrasion resistant
- Perfect for animals on board
- Included 12x piez of velcro (2,5cm x 2cm)



| Art. No. | for Gangway |
|----------|---------------------------------------|
| 8073 | „New-Mini“ 2m |
| 8074 | „Light“ 2m |
| 8075 | „Light“ 2,5m |
| 8076 | „Classic“ Alu 3m |
| 8077 | „Classic“ Teak 3m |
| 8078 | made to measure m ² |
| 8079 | Velcro strap 3M transparent per meter |



**Perfect for dogs and cats on board.
The material takes away the fear of
running over the gangway!**



**Custom made
Custom sizes built to order!**

Bags for Gangway



| Art. No. | for Gangway (100% PVC) |
|----------|--------------------------|
| 8091 | 2 m, folding |
| 8090 | 2 –2,5 m, 2x folding |
| 8092 | 2,5 m, folding |
| 8093 | 3 m, folding |



Gangway Bracket



- Solid and robust, easy to attach
- Keeps gangway free of ropes
- Unbreakable stainless steel V4A

| Art. No. | 1090 |
|--------------|----------------------|
| Material: | Stainless steel(V4A) |
| Size: | 530 x 180 mm |
| Weight Load: | approx. 500 kg |



Gangways

Gangway Accessoires: Gangway Holder

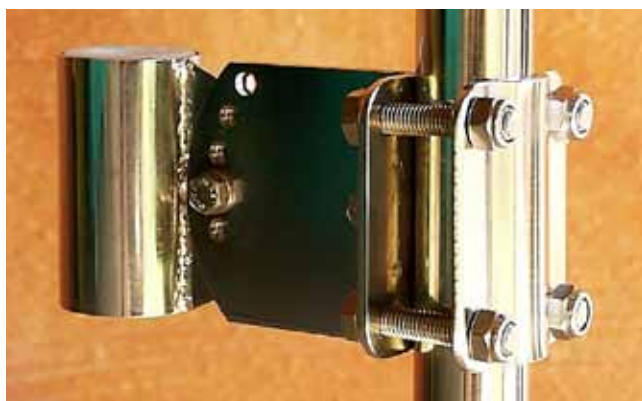

Adjustable Gangway Holder in stainless steel (V4A)

- Facilitates installation at stern or side-deck
- Variable angle of inclination
- Various sizes (see diameter of your gangway fitting)



Rail fitting for Gangway (V4A)
Attaches to all rails up to 30 mm diameter



8035



8036 - 8038

Rail fitting horizontal
Attaches to all rails with 25 mm diameter



8080 - 8082

| Art. No. | Core diameter | for Gangway |
|----------|------------------------|---------------------|
| 8036 | Ø = 20 mm | «Mini» |
| 8037 | Ø = 25 mm | «other models» |
| 8038 | Ø = 30 mm | «Light» + «Classic» |
| 8035 | inclusive counterplate | |

| Art. No. | Core diameter | for Gangway |
|-----------|--------------------------|---------------------|
| 8080 | Ø = 20 mm | «Mini» |
| 8081 | Ø = 25 mm | «other models» |
| 8082 | Ø = 30 mm | «Light» + «Classic» |
| Size: | 950 mm x 600 mm x 500 mm | |
| Material: | Aluminum anodized | |

Deck socket for Gangway (V4A)

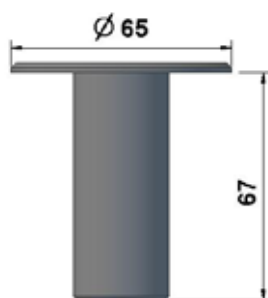

| Art. No. | Size | for Gangway |
|----------|-----------|---------------------|
| 8039 | Ø = 20 mm | «Mini» |
| 8058 | Ø = 22 mm | «other models» |
| 8059 | Ø = 25 mm | «other models» |
| 8060 | Ø = 30 mm | «Light» + «Classic» |

Storage bracket for Gangway (V4A)

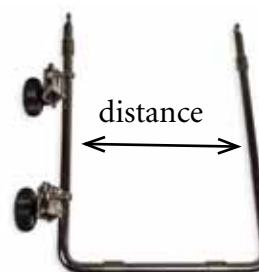

| Art. No. | for Gangway folding | |
|----------|---------------------|------------------|
| 8033 | «Mini» | distance: 110 mm |
| 8034 | «Light» | distance: 140 mm |
| 8032 | «Classic» | distance: 170 mm |

Our accessories can also be used with other makes of gangways. Just let us have the diameter of your gangway fitting.

Sail Repair Kit

The ideal gift for the Skipper!

- Compact
- Only includes high quality tools
- Tools for all types of repairs
- The bag is also available without tools



Contents:

- Sewing Thread
- Ahle
- Different needles
- Sewing Palm
- Marline spike
- Lighter
- Double side tape
- Insulating tape
- Combination pliers
- Scissors
- Screwdriver
- Marline spike
- Knife
- Sailcloth
- Adhesive Dacron
- Splicing Instructions
- Splicing Instructions

| Art. No. | 1060 | 1061 |
|------------------|-----------------|---------------|
| Case: | including tools | without tools |
| Colour: | blue | blue |
| Size: | 680 x 350 mm | 680 x 350 mm |
| Material: | Nylon | Nylon |
| Classifications: | 13 | 13 |



Toolbag



Do away with an unwieldy, impracticable and cluttered tool box!

- Toolbag available in two sizes!
- 20/30 pockets of various sizes
- Additional small bag with zip-fastener
- Adjustable strap
- Compact design
- Tools secured with velcro
- All tools are easy to find
- 40° C washable



Our tip:

We recommend the small tool bag for tools for daily use and the large bag for general tools.



| Art. No. | 1062 | 1067 |
|------------------|--------------|--------------|
| Colour: | blue | blue |
| Size: | 840 x 450 mm | 540 x 450 mm |
| Material: | Nylon | Nylon |
| Classifications: | 30 | 20 |

Bags

Combi bag

All in one bag

- 4 individual pockets
- Perfect for small boats
- For winchhandle, charts, etc.

| Art. No. | 6058 | 60581 |
|---|--------------|--------------|
| Colour: | white | silver |
| Size: | 470 x 360 mm | 470 x 360 mm |
| All bags supplied with suction cups and screws! | | |



Universal bag mini

Fast storage

- with elastic band
- Attaching with screws or lines

| Art. No. | 6059 | 60591 |
|---|------------|------------|
| Colour: | white | silver |
| Size: | 28 x 28 cm | 25 x 28 cm |
| All bags supplied with suction cups and screws! | | |



Bag for maps

The ideal bag for maps

- 4 individual pockets
- Can be mounted on a rail or on the wall with suction cups or screws

| Art. No. | 6059 | 60591 |
|---|--------------|--------------|
| Colour: | white | silver |
| Size: | 440 x 320 mm | 440 x 320 mm |
| All bags supplied with suction cups and screws! | | |



Made from indestructible material - suitable for inside and out!

- Strong
- UV-resistant
- Breathable, waterproof, netting fabric
- Rot-proof
- 30°C washable
- Recyclable
- Weatherproof
- Bags delivered with fittings (suction cups, screws, suction cups)
- Available in colour white and now also in silver
- Choice of attaching with screws or suction cups

Special sizes available on request

Universal storage bag

Storage bag

- Available in two sizes
- 4 / 6 individual pockets
- Fastener (Tenax)



| | | |
|-----------------|--------------|--------------|
| Art. No. | 6051 | 60511 |
| Colour: | white | silvegrey |
| Size: | 600 x 420 mm | 600x420mm |

All bags supplied with suction cups and screws!



Storage bag

Universal storage bag

- To fit on the galley or bathroom wall
- Suction cups and screws included



| | | |
|-----------------|--------------|--------------|
| Art. No. | 6057 | 60571 |
| Colour: | white | silver |
| Size: | 380 x 250 mm | 380 x 250 mm |
| Art. No. | 6050 | 60501 |
| Colour: | white | silver |
| Size: | 500 x 250 mm | 500 x 250 mm |



Mast Sheet Bag for halyard

Assures a tidy boat

- Easy mounting at the mast with 2 fastening buckles
- Quick stowage of halyards and therefore less chaos on bord
- No danger of loose ropes
- Easy handling

| | | |
|-----------------|--------------------|--------------|
| Art. No. | 6060 | 60601 |
| Colour: | white | silver |
| Size: | 550 x 220 x 160 mm | |

All bags supplied with 2 fastening buckles



Bags

Multi-purpose bag

Ideal for drinks, GPS, mobiles etc...

- Also suitable for bottles
- Can be mounted on a rail or on the wall with suction cups or screws

| Art. No. | 6056 | 60561 |
|----------|-------------|-------------|
| Colour: | white | silver |
| Size: | 210 x120 mm | 210 x120 mm |

All bags supplied with suction cups and screws!



Storage bag for winch handle

Storage bag for winch handle

- Available in two sizes
- Can be mounted on the mast or in the cockpit with screws

| Art. No. | 6053 | 60531 |
|----------|--------------|--------|
| Colour: | white | silver |
| Size: | 320 x 110 mm | |

| Art. No. | 6054 | 60541 |
|----------|--------------|--------|
| Colour: | white | silver |
| Size: | 400 x 130 mm | |

All bags supplied with screws!



Storage bag for ropes

Small and large bag for sheets and halyards

- Available in two sizes (350 x 280 mm & 400 x 350 mm)
- Ropes will dry very fast, due to special netting
- No mold growth

| Art. No. | 6055 | 60551 |
|----------|--------------|--------------|
| Colour: | white | silver |
| Size: | 350 x 280 mm | 350 x 280 mm |

| Art. No. | 6052 | 60521 |
|----------|--------------|--------------|
| Colour: | white | silver |
| Size: | 400 x 350 mm | 400 x 350 mm |

All bags supplied with suction cups and screws!



Exclusive Designs for the kitchen



At home or on board; Garlic-Press, Salt and Pepper Shakers

- In stainless steel and aluminium
- You can press more than 1 garlic clove at once
- No garlic spillage
- The garlic remains in a small case and remains clean
- Smoother than all the other presses (like butter)
- You can press the clove without peeling

Garlic press

| | |
|-----------------|-------------------|
| Art. No. | 9120 |
| Diameter: | 300 x 50 x 120 mm |
| Weight: | 1,8 kg |
| Material: | steel / Alu |

Pepper shaker

| | |
|-----------------|-------------|
| Art. No. | 9111 |
| Diameter: | 39 mm |
| High: | 46 mm |
| Material: | steel |

Salt shaker

| | |
|-----------------|-------------|
| Art. No. | 9106 |
| Diameter: | 39 mm |
| High: | 46 mm |
| Material: | steel |

Salt & Pepper shaker + wood

| | |
|-----------------|-----------------|
| Art. No. | 9112 |
| Size: | 95 x 65 x 55 mm |

Perfect gift for every sailor!



Drink- and Bottleholder for Guard Rails and Stanchions



Drinkholder



Bottleholder

Now drinks and bottles are at hand all the time!

- Easy and fast to fit
- Usable on the guard rail and on the stanchion
- You can attach up to 2 litre bottles
- Available as drink- or bottle-holder
- With a special adapter bushing (accessories) it is also usable on life-lines
- Available for stanchion diameter 25mm
- To attach just put-it on the guard rail or stanchion, turn-it by 90° and the holder clips on and it is attached
- An ideal present
- Polyethylene / stainless steel 316
- Weight: 250 g

Video Demo
www.swi-tec.com



Drinkholder for stanchion

| Art. No. | tube-Ø |
|----------|--------|
| 7900 | 25 mm |

Bottleholder for stanchion

| Art. No. | tube-Ø |
|----------|--------|
| 7902 | 25 mm |

Bushing for life-lines

| Art. No. | 7905 |
|-----------|--------------------|
| Material: | Rubber |
| Size: | L: 5,5cm, Ø 2,5 cm |



Drink Holder, set of two

The practical solution for glasses, tins and other small things!

Drink Holder

- Set of two drink holders
- No more spilled drinks
- Individual fittings
- Also holds handheld GPS, VHF etc.
- Easy to attach



Bottle Holder, set of two



Bottle Holder

- For bottles up to 1,5 l
- Set of two bottle holders
- No more spilled drinks
- Individual fittings
- Easy to attach



| Art. No. | 5073 |
|----------------|---|
| Size: | for drinks up to max. Ø 80 mm |
| Supplied with: | Set of 2 straps, 2 screw snaps and 2 suction cups |
| Material: | PVC, Velcro fastener |

| Art. No. | 6045 |
|----------------|---|
| Size: | Bottles up to. 1,5 l |
| Supplied with: | Set of 2 straps, 2 screw snaps and 2 suction cups |
| Material: | PVC, Velcro fastener |

Universal screw carry case

Universal screw carry case, Stainless steel VA4, AISI 316.

- Screws metric, split-pin, spring washer
- Appr. 360 pieces
- Easy to see
- Ideal on board or at home
- Easy to store
- Ideal gift for the skipper

| | |
|-----------------|--------------------------|
| Art. No. | 7001 |
| Size: | 320 x 260 x 50 mm |
| Weight: | 1,8 kg |
| Material: | stainless steel V4A, 316 |

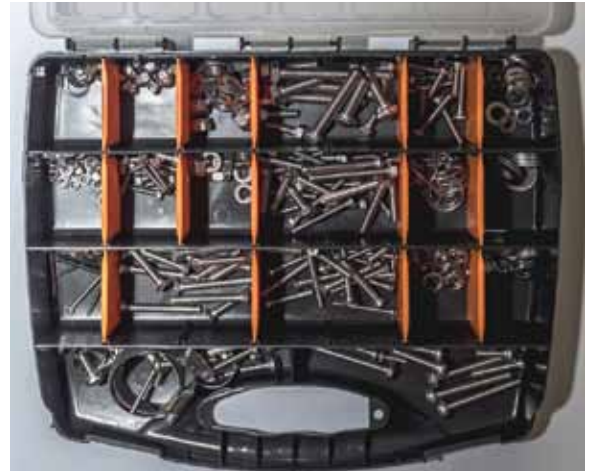

Sheet metal screws set

Sheet metal screws set Stainless steel VA4, AISI 316.

- Different sizes
- Set includes 430 pieces
- Easy to see
- Ideal on board or at home
- Easy to store
- Ideal gift for the skipper

| | |
|-----------------|--------------------------|
| Art. No. | 7007 |
| Size: | 320 x 260 x 50 mm |
| Weight: | 1,7 kg |
| Material: | stainless steel V4A, 316 |

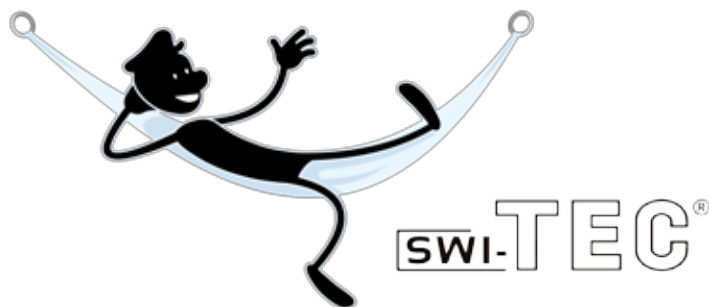

SWI-TEC Team



A familiar team, directly located at the production facility in Porto Cristo, Mallorca spares no effort offering you a wide selection of innovative products. From the idea over the realization to the commercialization, everything stays in our hands.



Together we are strong!
Our team works daily with pleasure to offer you the best possible service.

A extract of our work you will find all on our website or on our Social Media channels. We hope you will enjoy browsing through it!



WhatsApp
+34 744 649 362



SWI-TEC International



International - Worldwide

www.swi-tec.com

Distributors:

www.swi-tec.fr

 
www.swi-tecamerica.com
www.swi-tec.us

www.swi-tec.ch

www.swi-tec.es

www.swi-tec.it



www.swi-tec.de

www.swi-tec.nl

www.swi-tec.es

You wil find explicit information about all our distributors on our website
www.swi-tec.com below *Dealerlist*.

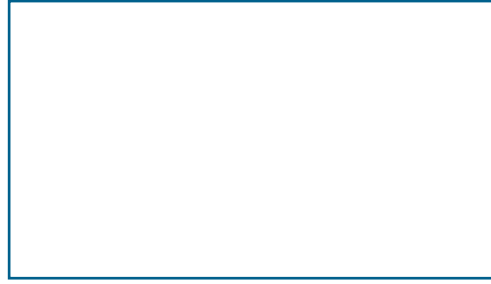
www.swi-tec.com



www.swi-tec.com

SWI-TEC[®]

