

SWI-TEC®

ALWAYS AN IDEA AHEAD



BOAT ACCESSORIES ONLINESHOP

WWW.SWI-TEC.COM

2025





The Team

A **familiar team**, directly located at the production facility in Porto Cristo, Mallorca spares no effort offering you a wide selection of innovative products and the best possible service.

Together we are strong!

The Production

We develop **special products** for everyday use on board to make life a little easier for you.



Our mascot *Maxi* will guide you through the catalogue.
Have fun



Mast Ascension

- 6 SWI-TECMastlift
Protective Cover
- 7 Mastlift Details
- 8 Bosun ´s Chair
Mastlift Universal Bag
- 9 Mastlift Accessories
Guide Roller
Endless Line
Masthead Harness
- 10 Mast Steps
- 11 Lifting Aid for wheelchair users
*Getting on board from a wheelchair:
Now it becomes easy and safe*

Help Aboard

- 12-15 Hydro Charger Standard
Charge your batterys under sail
- 16 Scarecrow «Universal»
No more birds fouling your boat!
- 17-18 Accessories for the Universal Scarerow
- 19 Scarecrow for Mast-Top and spreaders,
All-purpose Scarecrow
- 20 Outboard motor lift
Lifting Harness for outboard-motors
- 21 Rat Guard
*New sizes - also for commercial shipping and
super yacht*

Help Aboard

- 22 Dinghy Support
- 23 Fenderholder for stanchios
now also available in white
Clambling buckle for webbing
3M Dual Lock Velcro tape
- 24 Shroud Clips / Sail Tie
RopeFix

Anchoring

- 25 **NEW!** Chain Claw
Now also availabe for super yachts
- 26-28 Self-Adjusting Anchor Buoy
Anchor Buoy Accessories
Illumination
*You can see your Anchor-Buoy also
during the night*
Adhesives
- 29 Chain for Mooringbuoys
No more chafed ropes on Mooringbuoys
Stabilizer
- 30 Anchor - original BUGEL,
Powerball & Burglar-lock



Mooring

- 31 Retrieving Hook
- 32 Boat Hook
Anchor Clearing Hook
- 33 Mooring Line Hook for Lazy Lines
Easy mooring in the Mediterranean Sea ports
- 34 Safety Lock

Sun & Wind

- 35 **NEW!** Sun Awning Kit
suitable for motor and sailboats
- 36 Wind Scoop
Mosquito-net / Tenax
Reliable protection against insects
- 37 FixTop & RollTop
Provides shades on your boat
- 38 Winch Cover
Turnbuckle Cover

Security

- 39 Burglar Bars for Hatches
- 40 Emergency Ladder
- 41 Sailboat-Burglar Lock
«Standard»
«Deluxe»
Development for your security

Gangways

- 42-44 Gangways
*A big range of gangways!
Custom sizes built to order!*
- 45 **NEW! Non-slip mat for gangway**
Perfect for dogs and cats on board
Gangway Bag
Gangway Bracket
- 46 Gangway Holders

Bags

- 47 Toolbag
- 48 Combi bag
Universal bag mini
Bag for maps
- 49 Universal Storage bag
Storage bag
Mast Sheet Bag for halyard
- 50 Multi-purpose bag
Storage bag for winch handle
Storage bag for Ropes

Others

- 51 Garlic Press
Salt- and Pepper shaker
- 52 Drink- and Bottleholder
- 53 Screw carry cases
- 54 Introducing SWI-TEC
- 55 International SWI-TEC Dealerlist

SWI-TEC Mastlift



Video Demo
www.swi-tec.com

Give yourself a lift!

- Safe mast climbing
- Work alone at the top of the mast
- Both hands are always free
- No need for extra mast fittings
- Just hoist the Mastlift on the halyard of your choice (preferably two halyards for extra security)
- Reduction ratio: 10 : 1
- Multi purpose - Man overboard Recovery, General hoist
- Available in two sizes (height of mast: to 45ft and to 82ft)

The endless line is included.

Art. No.	1001	1002
Useful height:	to 13m	to 25m
Gear ratio:	1:10	1:10
Weight:	6,7 kg	7,6 kg
Size:	Ø = 165 mm; L = 215 mm	Ø = 185 mm; L = 215 mm
Permitted Live Load:	150 kg	150 kg
Breaking Load Dyneemaline:	2100 kg	2100 kg
Material:	Stainless steel (V4A), aluminium, high impact plastic	



German Lloyd certified!



Please give us the exact mast height when placing an order.



Mastlift Accessories: Protective Cover



We recommend our Neoprene Protective Cover to protect the unit and your mast.

Protects:

- the unit and the mast from impacts during operation
- the unit during storage
- eliminates chafing at the masthead

Art. No.	1005
Sizes:	for 13 m and 25 m mastlift
Material:	7 mm neoprene
Weight:	0,5 kg



SWI-TEC Mastlift



Bosun's Chair «Standard» and «XXL»



Safe and comfortable!

- With stitched-in wooden board
- Comfortable to sit on for hours of work
- Safe even if unconscious
- Strong fabric and workmanship
- 4 sewn-on bags for power tools, rigging tools, nuts and bolts etc.
- Sewn-in stainless steel shackle
- Compact storage bag included
- Fittings to hold drill
- Additional stitched loops for tools

XXL-Design

- Addition: Adjustable back-rest
- Larger wooden board
- Wider

★ **A great asset to your safety, our Bosun's Chairs are safe even in the event of loss of consciousness.**



Art. No.	2001	2000
Bosun's Chair:	«Standard»	«XXL»
Weight:	2 kg	3,7 kg
Permitted Live Load:	150 kg	170 kg
Strength of load bearing line:	2170 kg	3000 kg
wooden board:	47 x 21 x 1,5 cm	50 x 24 x 2 cm
Material:	Cotton-polyamid blend, water resistant	
Waist circumference:	125 cm	145 cm

Mastlift Accessories: Universal Bag



A sturdy, attractive and versatile bag on board or at home!

- The mastlift is always at hand
- The perfect bag for the mastlift and its accessories
- Keep dampness out

Art. No.	3009
Material:	cotton and polyamid blend with foam rubber inside
Weight:	0.8 kg
Size:	400 x 250 x 250 mm



Mastlift Accessories: Guide Roller



Allows the use of mastlift at sea!

- To be used around the furled genoa or jib
- Using the Guide Roller will prevent the mastlift hitting the mast
- Can also be used as a guide for light sails

Art. No.	1003
Material:	Turned from solid beech wood, cable stainless steel
Size:	700 mm



Mastlift Accessories: 4 m Endless Line



May be used as a hoist in the following situations!

- Man over-board retrieval
- Lifting an outboard motor or recovery of a dinghy
- Lifting heavy equipment for example, batteries and generator etc.



Art. No.	1004
Size:	4 m
Line:	Ø 10 mm spliced



Mastlift Accessories: Masthead Harness

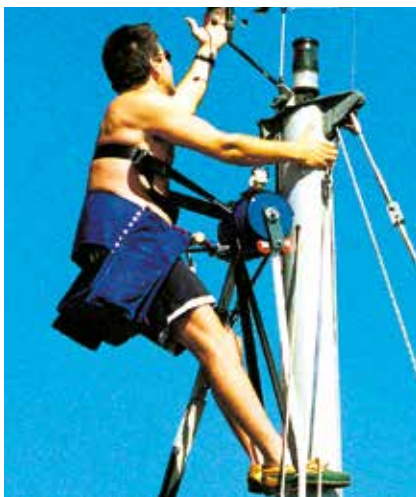

Enables you to work above the masthead!

- The Masthead Harness ensures safety as you work at the masthead
- Ideal for the installation or repairs of masthead equipment
- Adjustable to any body size



Art. No.	1006
Material:	50 mm polyester
Load:	1000 kg



Mast Steps stainless steel or plastic



The alternative way to the top!

Fixed Mast Steps in stainless steel

- Includes ring for the guide line
- Simple and strong construction
- V4A Stainless steel
- Well designed
- Blends in with the mast
- Universal fit
- Light weight

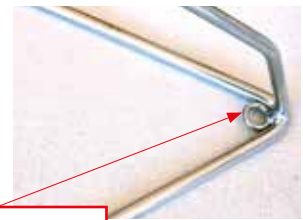

ring for the guide line



Art. No. 1009

Maststep

Ausführung:	6 drill-holes
Material:	Stainless steel (V4A)
Sizes:	200 x 200 x 170 mm
Weight:	170 g



Art. No. 1068

Maststep foldable

Fixings:	5 drill-holes
Material:	GfK / Nylon
Sizes:	148 x 77 x 35 mm
Weight:	164 g

Folding Mast Steps in plastic

- Suitable to use in conjunction with the SWI-TEC mastlift instead of the masthead harness
- Reinforced plastic / nylon
- Easy to open and fold
- Does not rattle



Art. No. 2002

Rivets Monel

Fixings:	Clamping length 8-11 mm
Material:	Monel
Sizes:	Ø 4,8 x 16,5 mm

SWI-TEC Lifting aid for wheelchair users

Mast lift with special seat for wheelchair users

Getting on board from a wheelchair: Now it becomes easy and safe. The newly designed, faint-safe seat makes life easier for people with disabilities.

Now it becomes so easy and safe for wheelchair users or for persons who find the railing an unsurmountable obstacle to go on board or off board.

- Makes it easy and safe for people with disabilities to experience sailing
- Exclusive: We have a special lift system for use on board
- Smooth and safe transfer from the landing stage to the vessel
- No mast fittings required
- When required simply hook the unit on the main boom or mizzen boom
- Most versatile – also for man overboard maneuvers



Art. No. 5091 Chair for handicapped persons

Weight: 1,8 kg
 max. load (person): 150 kg
 Material: Cotton/polyamide mix
 Polyester belts
 Stainless steel cross-bar,
 spring hook and rings
 Including water resistant bag for stowing

The Mastlift Art. 1001 and 1002 is not included and must be ordered seperately.



Hydro Charger

Now you can have enough power on board with our new Hydro Charger

Charge your batteries under sail by lowering the generator in the water

- Very robust stainless-steel construction (Aisi 316)
- Adjustable according to the inclination of the mirror, ensuring the generator always enters the water vertically
- Base plate on the mirror with a massive counter plate (also available separately)
- Easy attachment and detachment with a snap lock and safety feature
- Can be raised and folded down at full speed thanks to a 4-fold rope translation
- Automatically locks into working position, preventing tension on the line during the journey
- Can be immediately released by a sudden pull with a separate line, for hoisting or in case of a collision
- Can be folded vertically upwards when not in use or when the batteries are charged
- Side stops as limits in the water and during hoisting
- Ergonomic design
- Maintenance-free

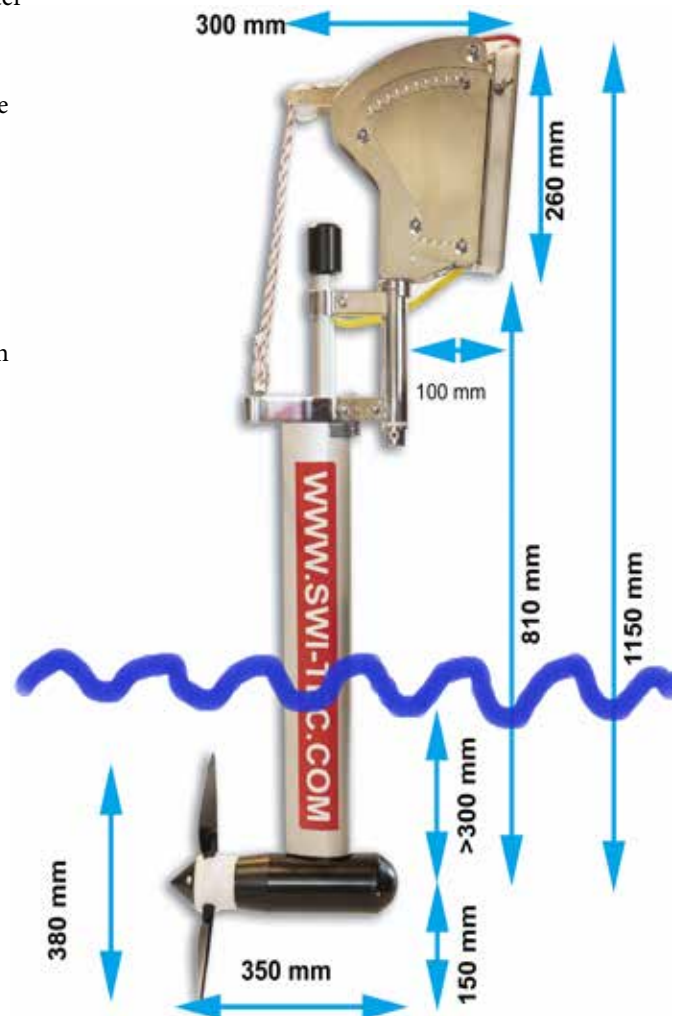

Hydro Charger Standard

Art. No. 7147 (12V) 7148 (24V) with standard bracket

Size: 110 x 10 x 30 cm Weight: ca. 18 kg



Attention!

For the use with lithium-ion battery

It is possible to operate the Hydro Charger with lithium batteries, but always in consultation and with permission from the battery manufacturer!

In this case, a switch relay must always be installed between the Hydro Charger and the Charge Controller, as otherwise, our regulator could suffer damage.



Included in the delivery

Generator



- Smooth running through custom-designed planetary gear
- Low ratio prevents high motor speeds
- Optimized efficiency through custom-designed transmission
- Double seals (2 O-rings each)
- Multiple-bearing propeller shaft
- Easy to remove and disassemble
- Hard anodized aluminium housing and synthetic cover.
- Streamlined anodized aluminium body
- All screws are stainless steel (A4)
- No propeller forces transmitted to the gearbox due to special coupling
- Almost inaudible in the water
- Charging from 4 knots upwards (depending on the pitch setting of the propeller blades)

Regulator



- Up to 16/32 volt adjustable, perfect to compensate voltage loss
- With built-in free wheel (propeller turns freely when the max. retained battery voltage is reached)
- Additional connection for solar panels or wind generator
- Additional connection for direct output, which will be automatically shut down when it has sufficient battery voltage
- **NEW:** integrated digital display
- **NEW:** additional switch for free wheel
- **NEW:** additional alarm when battery is completely charged
- **NEW:** more output

Propeller



- Main body manufactured in a solid synthetic material
- Stove enamelled aluminium propeller blades
- Blade angle is infinitely adjustable depending on type of the boat (speed)
- Propeller blades are replaceable (i.e. after collision)
- Blades CFD (software for numerical solutions) are designed specifically for generator with optimized form and twisting

Standard bracket



- Including screws, nuts and security bolt
- Stainless steel bracket with middle section in plastic and counter plate

Technical data

Mechanism to lift Stainless steel bracket with adjustable segment, folding-up with a line. Folding under speed is no problem, because there is a line reduction with 4x ratio. The generator is locked in position when deployed in the water. Quick fastener device for mounting on transom bracket.

Generator with Converter Charger without mounting bracket

Generator part: Gear drive with shaft, propeller and programmable converter charger with digital display and 4 m 3-core cable
 Performance: Generates power from 4 knots (depending on boat speed and adjustment of the propeller blade pitch)
 Output: 50 to 500 Watts depending on speed and battery load
 Generator Dims.: Gear drive with shaft and bracket: 1100 x 100 mm, propeller diameter 360 mm

Charger:

Rated Power: 1.000W (Best ratio: Hydro Generator 600W, PV cells 400W, max. 60vdc)
 Applicable batteries: 12V/24V from 200Ah/100Ah (voltage detected automatically)
 Battery full charge cut: 16V/32V (adjustable)
 Battery low voltage disconnect load: 11V / 22V
 Load on voltage: 12,44V (default)
 Load current max: 40A (20A at 24V)
 No load loss: ≤45mA
 Dimensions: 278 x 133 x 75 mm
 Weight: 1,6 kg
 Working environment: Working temperature: -10-50°C Relative humidity: 0-90%
 (no exterior installation, only inside the cabin)

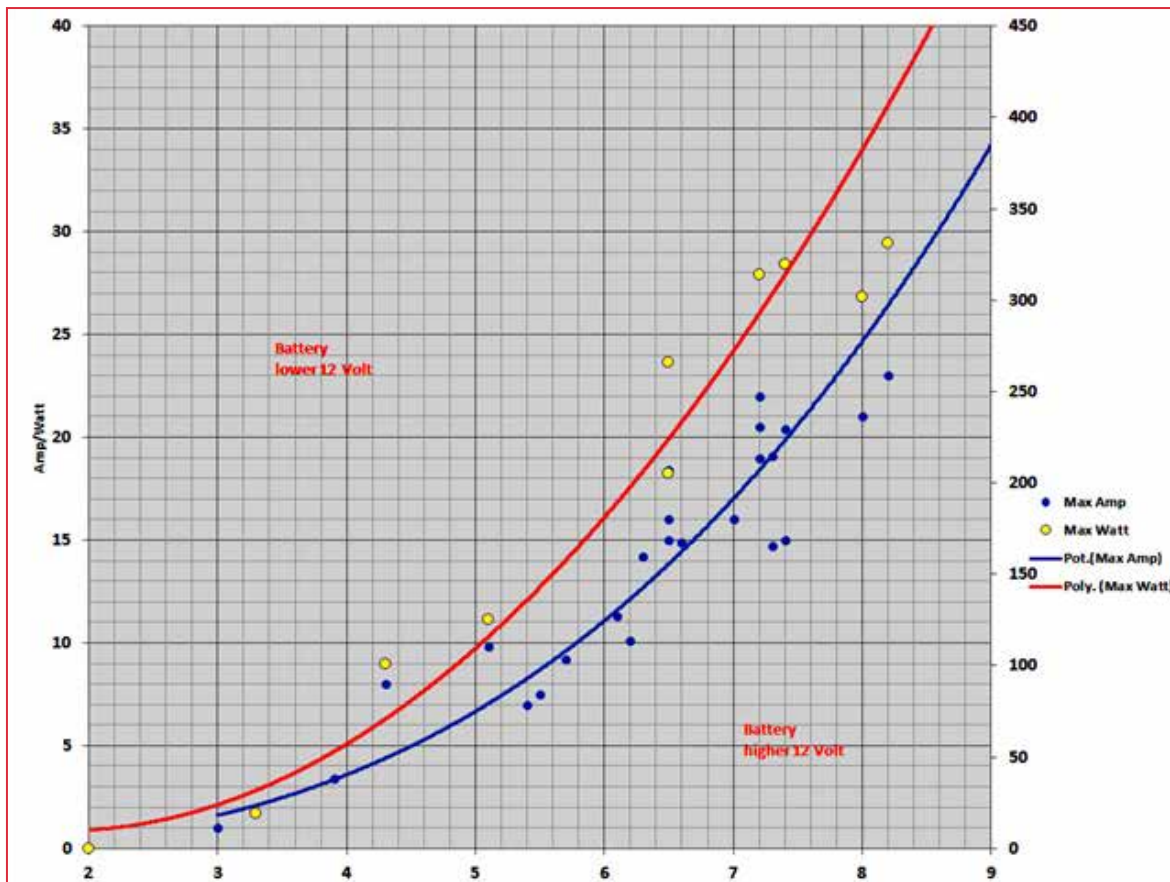

Accessories

Support for swim platforms

With our special support, you can attach the Hydro Charger to almost any platform.

Art. No.	7210
Material:	Stainless steel
Size:	265 x 70 x 260 mm
Weight:	ca. 2,4 kg



Standard bracket

Stainless steel bracket with middle section in plastic and counter plate
Including screws, nuts and security bolt

Art. No.	7220
Material:	Stainless steel
Size:	260 x 70 x 30 mm
Weight:	ca. 2 kg



Universal Scarecrow

The new and versatile Scarecrow

The «Universal» scarecrow is composed of a base, 9 polyester rods with small balls at the ends, as well as a mounting flange. The flange is just 15 mm and can be permanently installed in any position with just 2 screws.

The unit is mounted by simply clipping and twisting through the bayonet-lock. Push down the safety bolt afterwards and the scarecrow is ready-to-use.

The polyester rods are individually replaceable and can be removed according to demand, i.e. single rods can be removed for mounting on individual swim platforms.



Art. No. 2100	Universal Scarecrow
Material:	Nylon, wires polyester
Size:	L = 1,60 m
Diameter open:	Ø ca. 2,7 m
Weight:	0,7 kg

Including water resistant bag for stowing



Accessories for the Universal Scarecrow

Art. No. 2106 Main boom bracket

Material: Plates PVC
 Size: 15 x 15,5 cm
 Weight: 0,25 kg

With 1.5m long straps and 2 adjustable clamp buckles, the seagull stop fits on almost all sailing yachts (even with attached sails). The holder is fixed to the main boom using straps and buckles and the scarecrow is attached with the bayonet lock.



Art. No. 2110 Rail bracket

Material: Nylon (Delrin)
 Size: Disc Ø = 80 mm
 Weight: 0,5 kg

The bracket can be screwed on the railing or handrails permanently or just temporarily. The flange with bayonet-lock is already fitted to the bracket.



Art. No. 2105 Canopy bracket

Material: Nylon, Plates PVC
 Size: 220 x 180 mm
 Weight: 0,3 kg

The canopy bracket will be delivered with the flange, 2 plastic plates and screws. In a suitable position cut 2 small holes in the canopy for the screws. The two plates are then attached to each other, one on each side. The plates with the flange remain permanently attached to the canopy.



Art. No. 2102 Extra support

Material: Nylon
 Size: Disc Ø = 80 mm

The extra support for another installation of the Universal Scarecrow



Accessories for the Scarecrow Universal

Art. No. 2111 Support telescop

Material: Stainless Steel V4A,
Size: Extendable, 0,70 m - 1,3 m,
tube diameter 25/30 mm
Weigth: 1,5 kg



The telescopic rod made of indestructible stainless steel allows the placement of the Universal Scarecrow on bathing platforms and equipment carriers. It is light, handy and quick to assemble and disassemble.

Simply set up and fix the telescopic rod, then attach and secure the Universal Scarecrow with the quick-release fastener.

3 loops give you the opportunity to secure the telescopic, for this we recommend our mounting kit (Art. 2072 / P.18).

Art. No. 2071 Mounting foot

Material: PVC / anodised aluminium
You would like to set up your Scarecrow or do not have the option to attach it well on board. We have also developed the perfect solution for this with our ajustable foot. The integrated ball joint provides the necessary flexibility. In connection with the telescop art. no. 2111 and the mounting kit art. no. 2072 they create an additional support.



Art. No. 2072 Mounting kit

Material: Polyester straps and quick connections
Our mounting kit is suitable for the telescopic bracket.

The 3 polyester belts (4 m x 3 cm) with quick lock give a secure hold and you can enjoy life on board, free of bird droppings.



Art. No. 2081 Universal railing bracket

The universal holder can be used for the Scarecrow Universal with the telescop or all objects with a rod up to Ø 32 mm. The opposite side can reach an opening of up to 42 mm (round or square) and can be fixed in any position up to 360°.



Scarecrow for Mast Top

Protect your Mast top, arches etc. from seagulls

Newly developed scarecrow for the top of the mast. The rotating center section provides an even greater deterrent and the angle is adjustable.

The scarecrow is also useable on arches, cabin roofs and more.

Art. No.	2091
Model:	Mast top / Arch
Material:	PVC, Alu Anodised, polyester „wires»
Size:	H = 0,5 m, Ø ca. 1 m tube: Ø 22 mm



Scarecrow for Spreaders extendable

Protection for your spreaders!

The seagull protection system is characterized by its simple plug-in system, which allows you to connect an infinite number of parts together. This means that long area such as spreaders can be effectively protected from bird droppings.

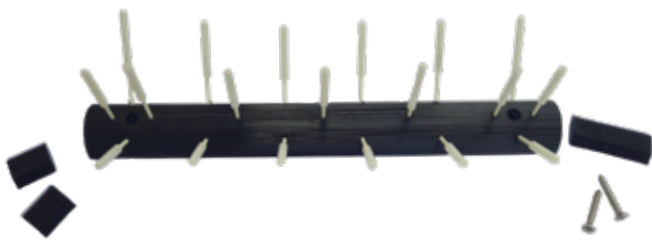

Art. No.	2090
Model:	Spreaders
Material:	Plastic, polyester rods with protective caps
Size:	25 x 3 x 6,5 cm

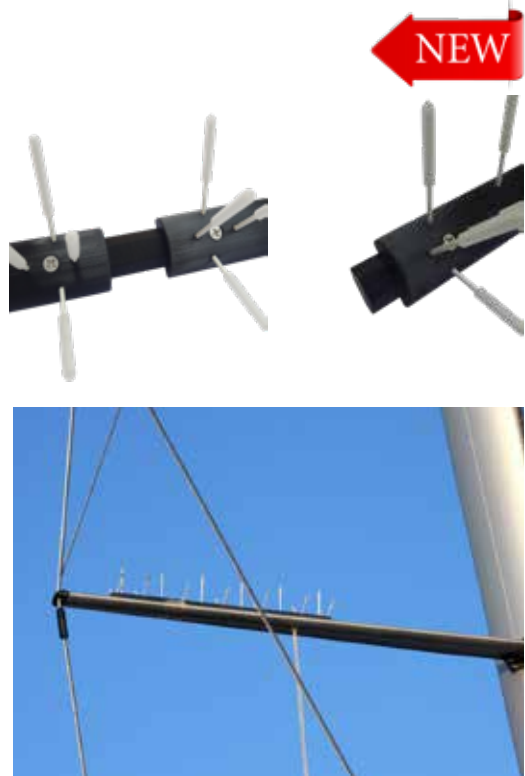

All-purpose Scarecrow

Drive away pesky birds and effectively shield your areas from bird droppings with our innovative All-Purpose Bird Deterrent. This high-quality solution is specifically designed for small areas and can coverage a diameter of 50 cm.

Art. No.	2092
Material:	Nylon (Delrin), Polyester rods with protective caps



Outboard motor lift

The crane can be attached to the railing or railing stanchions!



More security and easy handling of your outboard engine!

- 4-power reduction
- Simple application
- Is only fixed with one just screw
- Delivered ready to use
- Double tube for more load capacity
- Long life thanks to stainless steel
- Also ideal for bringing your provisions aboard
- For vertical or horizontal railing diameters up to 30 mm

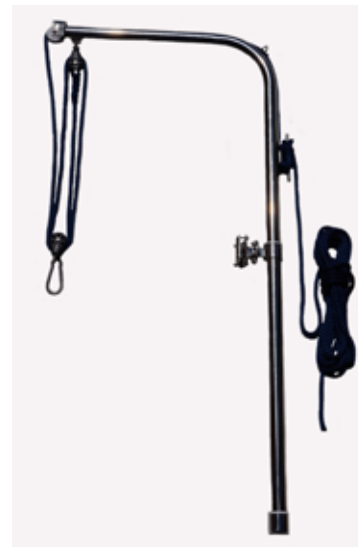

Art. No.	5200
Rope:	15 m up to Ø 75 mm
Size:	150 70 cm
Material:	Stainless steel (AISI 316)
Load capacity:	up to 100 kg
Weight:	6,5 kg
Pipe diameter:	Ø 42,5 x 2,6 mm



Thanks to the guide sleeves, the lift can be removed quickly when not in use.



Perfect in combination with



Lifting Harness for outboard-motors



The perfect solution!

- Carry the motor safely and comfortably
- Also for new outboard motors
- The lifting harness can remain attached



Art. No.	4042
used for:	2- to 4-HP-motors

Art. No.	4045
used for:	4- to 20-HP-motors

Material:	100 % polyester
Breaking Load:	100 kg



Rat Guards for ropes



Video Demo
www.swi-tec.com

Prevention is better than Cure!

- Rotating disc
- No more vermin on board
- Easy to use
- Very effective
- Compact
- May be used at anchor or in port
- Also usable for the anchor chain
- Replaceable rubber inserts

For the commercial shipping & super yachts

Art. No.	1125
Rope size:	up to Ø 75 mm
Size:	Ø 800 mm
Material:	PVC / Polystyrol
Weight:	2,7 kg

Art. No.	1122	1124
Rope size:	from 15 mm to Ø 30 mm	up to Ø 45 mm
Size:	Ø 360 mm	Ø 450 mm
Material:	PVC / Polystyrol	
Weight:	500 g	900 g

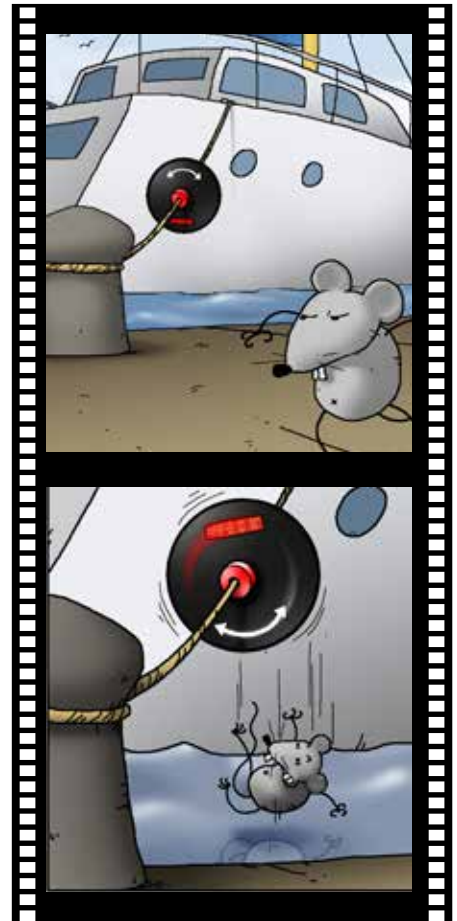

Swing-Away Dinghy Stowage

The easy way to store your dinghy!

- Perfect for Motorboats and Sailboats
- With security bolt in 2 positions
- Easy to handle
- Adjustable to suit the hull of your dinghy (cutting required)
- Reinforcement plates provided
- Solid stainless steel with bronze bearing
- High load capacity



Video Demo
www.swi-tec.com



Art. No. 8030

With wood-support (wood cutting required)

Material: Stainless steel Aisi 316 / Teak-Wood (Iroko)

Parts: 2 pieces (right and left) incl. counter-plates, 2 straps and screws

Max. Load: 250 kg every bracket, weight: 24 kg each

Size: Overall: 1080 mm, plates: 250 x 180 x 8 mm, length wood: 900 x 60 x 200 mm



Removable Dinghy Supports for platforms and decks

The easy and secure way to store your dinghy whilst under way.

- Suitable for swim platforms and decks with space for one dinghy i.e. Jetski
- The platform remains free of clutter when dinghy is in the water, the wooden supports are only plugged into place when required.
- The wooden support can be cut to suit any boat profile (delivered as shown in picture).



Art. No. 8027 The complete set screwable

Material: Stainless Steel V4A / Teak-Wood (Iroko)

Contents: 4 deck discs, 4 angle brackets, 4 ergonomic handles, 2 straps with 4 strap holder, 2 wooden supports (cutting required), screws

Weight: 6 kg

Size: Wooden Support: 600 x 50 x 100 mm, Disc: Ø 65 mm, Angle 70 x 40 x 50 mm



Art. No. 8028 The complete set pluggable

Material: Stainless Steel V4A / Teak-Wood (Iroko)

Contents: 4 Sockets, 4 plugs with bolts, 4 Double Pad-Eyes to secure, 2 Straps, 2 wooden dinghy supports (cutting required), 40 screws

Weight: 4 kg

Size: Wooden Support: 600 x 50 x 100 mm, Sockets: Disc Ø 40 mm, Depth: 50 mm, Outside diameter sleeve: Ø 15 mm



Dinghy mount parts separate

Art. No. 802800 Dinghy holder deck sockets (Set of 4)

Sockets: Disc Ø 40 mm, Depth: 50 mm

Outside diameter sleeve: Ø 15mm

Plate Counterpart: 60 x 40 mm

Material: Stainless steel Aisi 316, incl. screws

Drill-hole: Ø 4 mm

Art. No. 802700 Angle bracket for dinghy holder (Set of 4)

Size: 70 x 40 x 55 mm

Deck disc: Ø 65mm

Material: Stainless steel Aisi 316, incl. screws



Fenderholder for stanchions

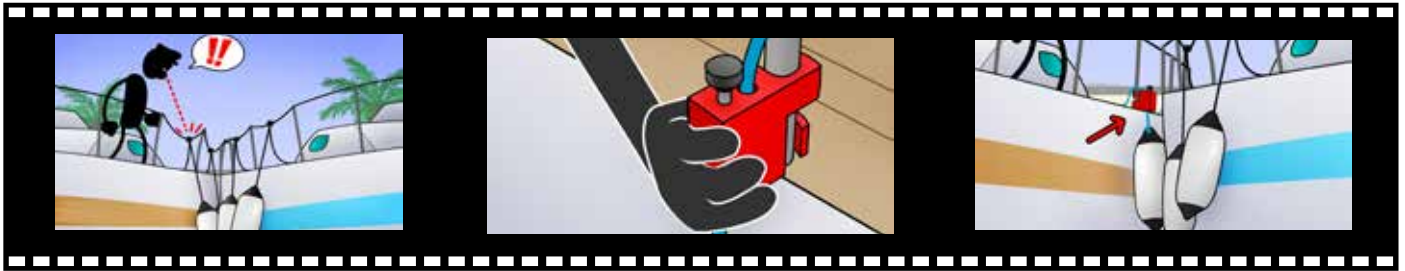

The perfect place to attach the fenders!

- Fast and easy to attach
- Easy to adjust the height
- The line stops by pressing on the black button
- No more high loads on the life lines
- Now you can use shorter fenderlines
- More attractive, because you don't have any more long lines on the guard rail
- Available for 2 different stanchion diameters (25 and 30 mm)
- Fender can remain permanently on the fenderholder
- By turning the holder 90°, take it off and stow it completely with fender in a locker
- A really nice gift
- Economically priced in a set of two
- With safety lock



Fenderholder in red (Set of 2)

Art. No.	2061	
for stanchion-Ø:	25 mm	
Colour:	red	
Material:	Polyethylen / stainless steel 316	
Size:	from 6 mm up to 12 mm fenderlines	
Weight:	120 g (130 g)	

Fenderholder in blue (Set of 2)

Art. No.	20611	20621
for stanchion-Ø:	25 mm	30 mm
Colour:	blue	blue
Material:	Polyethylen / stainless steel 316	
Size:	from 6 mm up to 12 mm fenderlines	
Weight:	120 g (130 g)	

Clamping buckle for webbing

Art. No.	507419	404509
for webbings:	20 mm	25 mm
Size:	3,5 x 3,0 cm	4,7 x 3,7 cm
Material:	Aluminium, anodized (DIN 5292)	



3M Dual Lock Velcro tape

Art. No.	8079
Width:	2,5 cm
Size:	3,5 x 3,0 cm
Order unit:	1 meter

Attention: 1m Dual Lock Velcro effectively produces 0,5m



Shroud Clips

Use the shrouds... the space saving stowage solution!

Shroud clip for boathook

- Easy to install
- Boathook is always ready for action
- Velcro fastener included

Shroud clip with hook

- For anything that can be hung (can be used from Ø 4mm)
- For securing the gangway at the quarter-deck
- For attaching a tarpaulin or sun shade

Shroud clip for RopeFix

- Suitable for all ropes
- Ropes will dry easily
- Also suitable for a water-hose



Art. No.	Stainless steel V4A
2042	Shroud clip for boathooks
2043	Shroud clip for RopeFix
2045	Shroud clip with hook



Sail Tie

The easiest and most practical way to wrap your sail!

- White webbing straps
- UV-resistant
- Washable
- No more springing bungee cord
- Secured with an adjustable clip buckle
- Quick and easy handling
- Individual fittings



Art. No.	5060	5070	5071
	Sail tie »S«	Sail tie »M«	Sail tie »L«
Boom length:	2,5 – 4 m	4 – 5 m	5 – 6 m
Belts:	4	5	6
Colour:	white	white	white
Material:	3 cm Polyester belts		

RopeFix - Lineholder (Set of 3)

No more messy lines!

- No more messy lines
- Easy to install
- Multi purpose

Art. No.	2051
Size:	Ø = 35 mm
Length:	300 mm
Weight:	15 g



Chain Claw «Standard» and «Deluxe»

Protects your anchor winch and have a good night's sleep!

- Easy to use, with our boathook much easier «Deluxe»
- No more noise from the anchor chain
- The hook can also be released under strain
- Hook the chain and cleat off rope, the strain on the chain and winch is eliminated
- The Chain Claw acts as a shock absorber
- With 5 meter spliced line
- The hook can also be released under strain together with the tripping line («Deluxe»)



Model «Deluxe»

- Can be released from board with the hole line.
- Easier hanging on the chain with our special boat hook

To be used in conjunction with a SWI-TEC telescopic boat hook, adaptor or boat hook tip (P.33).

NEW: You will receive the boat hook adapter free of charge with the delivery of the deluxe models!



Chain Claw for Catamaran «Standard» and «Deluxe»

- As above but with 2 spliced lines, each of 6 m
- Available for 8 - 13 mm chain



Now also available for Superyachts



	Superyacht			Superyacht	Superyacht	Catamaran	Catamaran	Catamaran
for Chain:	6/8 mm	10 mm	12/13 mm	10 - 16 mm	18 - 22 mm	8 mm	10 mm	12/13 mm
Max. Load:	1000 kg	1200 kg	1600 kg	3500 kg	4500 kg	1200 kg	1200 kg	1200 kg
Weight:	0,6 kg	0,6 kg	0,6 kg	0,8 kg	1,4 kg	0,8 kg	0,8 kg	0,8 kg
Size length:	120 mm	120 mm	120 mm	220 mm	250 mm	120 mm	120 mm	120 mm
Line spliced:	5 m line	5 m line	5 m line			2x6m line	2 x 6 m line	2 x 6 m line
Size / line:	Ø 12 mm	Ø 14 mm	Ø 14 mm			Ø 12 mm	Ø 14 mm	Ø 14 mm
«Standard»	1028	1029	1038			10282	10292	10382
«Deluxe»	10283	10293	10383			10284	10294	10384
«without line»	10281	10291	10381	1041	1070	10281	10291	10381

Self-Adjusting Anchor Buoy

The Original

Lifting ring to pick up the buoy

Stainless steel (V4A)

SOLAS reflective safety tape to make the buoy visible for everyone in the dark

Specially designed self-rolling strap mechanism

Edge protection for optimum security

Solid but light weight plastic body



Belt with strength up to 1100 Ibs (500 kg)

belt length up to 20 m
Line extension with 10 m belt possible

Video Demo
www.swi-tec.com



Mark your anchor with the «ORIGINAL» SWI-TEC Anchor Buoy!



- Often copied but never matched the quality
- More than 25 years on the market!
- To a maximum water depth of 65 feet
- The buoy is always positioned directly above the anchor
- Unique, specially designed self-rolling belt/strap mechanism
- No complicated calculations for guessing the length of line let out
- Tripping the anchor is easy
- A tensile strength of up to 1100 Ibs
- Precisely marks the anchor's set position
- Safety reflector (3M)
- Can function as a tripping line

New: line extension for Anchor Buoy

Art. No.	1020	1027 Line extension
Size:	Ø = 300 mm, H = 420 mm	
Lenght:	20 m webbed belt	10 m webbed belt
Weight:	3,5 kg	
Strength of belt:	500 kg	
Material:	High impact plastic; Stainl. steel	



Buoy Rack



Your anchor buoy is always ready to use!

- Has been designed especially for the SWI-TEC anchor buoy in stainless steel
- Double spring security clips
- Can be easily attached to the pulpit rails
- Adjustable angle
- **Ideal:** Support can also be mounted in the anchor locker



Art. No.	1021
Size:	Ø = 350 mm, H= 130 mm
Rail:	Ø = 18 – 30 mm
Weight:	0,7 kg
Material:	stainless steel (V4A)

Just leave the 2 back parts of the clips and the support can be easily mounted

Anchor Buoy Light

Flashing Light for your anchor buoy!

- Automatic on/off due to twilight switch
- Turn off if not used tuning the cap
- LED Blinking
- Power Save
- Water resistant
- Range of sight 1 nm approx.
- Retrofit for all SWI-TEC Anchor buoys
- Including 2x AA batteries



Art. No.	1014
Size:	Ø = 40 mm, H = 200 mm
Weight:	200 g
Interval:	Approx. 40 Flash / min.
Range:	Approx. 1 Nm
Material:	Plastic



Boat name lettering, prohibited anchoring decal

Mark your anchor buoy!

- The decals forbidden anchor decal prevents mooring by mistake
- Your own ship name makes it less likely that the buoy is used or stolen



Art. No. **1022**

Boat Name Lettering

Art. No. **2041**

Prohibited Anchoring Decal

Chain for Mooring Buoys

No more chafed lines on Mooring Buoys

- Pass your mooring line through the ring, cross the lines and attach it to your cleats
- Easy handling
- High quality stainless steel chain
- Best quality ropes (Liros)
- 3 different versions for boats up to 10 m / 15 m / 20 m

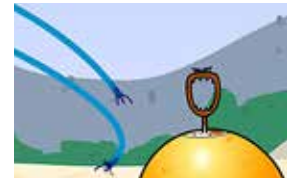

Art. No.	1220	1221	1222
Length of the boat:	up to 10 m	up to 15 m	up to 20 m
Chain stainless steel:	1,4404	1,4404	1,4404
Measure of the chain:	Ø 8 mm	Ø 10 mm	Ø 10 mm
Diameter of the rope:	Ø 14 mm	Ø 18 mm	Ø 22 mm
Material:	Polyester PES	Polyester PES	Polyester PES
Length of chain and rope:	1 m + 2 x 5 m	1 m + 2 x 6 m	1 m + 2 x 6 m
Breaking load:	3600 kg	6000 kg	9000 kg

Stabilizer

Anchor comfortably, without rocking!

- Dampens the roll from waves by up to 50 %
- Easy to use
- Supplied individually, (see table below)
- Foldable
- Compact storage bag included
- To be attached at the bow or on the side

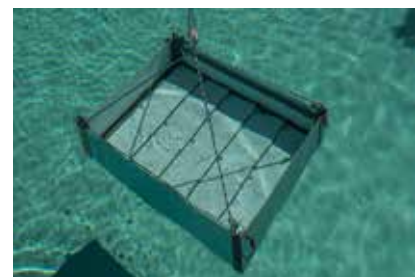

Weight in tons	5		10		15		20		25	
Reduction of the movement of the boat	50%	-30%	-50%	-30%	-50%	-30%	-50%	-30%	-50%	-50%
Number of recommended Stabilizers	1	1	2	2	2 - 3	2	2 - 4	2 - 3	3 - 5	

Art. No.	1085
Material	Inox V4A
Size:	450 x 600 x 190 mm
Size when folded:	450 x 600 x 60 mm
Weight:	8,2 kg
Delivery:	each stabilizer in bag



Tip:
We recommend to fit the stabilizers on the same side!



The Perfect Combination

ORIGINAL Anchor and Anchor Connector

Since its introduction and patenting this **anchor** has been in service world-wide under extreme conditions and has proven to be a super all-purpose anchor:

The ability to set quickly and hold in the most difficult grounds such as mud, clay shale, gravel, rock and seaweed is the principle benefit of this truly universal anchor.

After stringent tests the German Lloyd's issued the certificate: «Anchor with high holding ability». As standard, it is supplied with a glass bead blasted surface (scratch-resistant).

The **Powerball** is the perfect anchor-to-chain connector. The full swivel ball and socket design permits the rotation around its own axis and swivels up to 30° in all directions. It is considerably stronger than the matching chain and is also certified by German Lloyd's.



THE ORIGINAL



Bracket Anchor (AISI 316L)

Art. No.	Weight
8013	14 kg
8014	18 kg
8015	25 kg
8016	30 kg
8017	42 kg



Anchor Connector Powerball



Art. No.	Chain	Anchor weight
8000	6 mm	6 – 11 kg
8001	8 mm	18 – 25 kg
8002	10 mm	18 – 30 kg
8003	10 – 13 mm	> 30 kg
8004	13 mm	42 – 52 kg
8005	16 mm	52 – 60 kg
8019	20 mm	> 60 kg



Burglar-lock

Burglar-lock for anchor and Powerball

- Anchor and Powerball are secured against theft
- The solid designed as stainless steel lock (V4A) can be fixed quickly, easily and effortlessly as a lock between anchor and connector

Art. No.	8020
	for anchor and Powerball, stainless steel

Mooring Buoy and Retrieving Hook

To attach a buoy quickly, easy and safely!

- Two hooks in one
- Easy release from moorings (trip line included)
- Easy tying up in locks
- Simply clip on to the ring of the buoy and cleat off the line on board
- By tightening the screw you can retrieve the anchor buoy or other items that may have fallen over board
- Both sizes include 10 m spliced lines
- Available in two sizes



To be used in conjunction with a SWI-TEC telescopic boat hook, adaptor or boat hook tip.

NEW: You will receive the boat hook adapter free of charge with the delivery!



Tip:
Up to 8 tons you should chose the standard size.
More than 8 tons we recommend the heavy-duty version.



Important: Don't use it for permanent tie-up!

Art. No.	1031 Standard	1034 Strong
Permissible Load:	1200 kg	3500 kg
Supplied with:	10 m line, Ø 12 mm 10 m line, Ø 4 mm	10 m line, Ø 14 mm 10 m line, Ø 4 mm
Size:	110 x 190 mm	120x200 mm
Weight:	1 kg	1,5 kg
Material:	stainless steel Ø 10 mm	stainless steel Ø 14 mm

Boat Hook and Accessory Adaptors

A heavy telescopic boat hook with nylon hook and accessory adaptor!

- The telescopic boat hook - adjusts from 1,17m - 1,96m
- Compatible with all SWI-TEC accessories
- Boat hook tip for up to 25mm pipe to convert existing hook to take SWI-TEC accessories
- Plastic boat hook adaptor to convert existing hook to take SWI-TEC accessories (1 up to 25 or 30 mm diameter pipe)
- Adaptor with counter plate 25mm
- Including Screws



Tip:

Regularly clean your telescopic boat hook with fresh water.

Adapter to remove

(for charter) to bolt down with counter plate with screws and nuts.

Art. No.	2031 Telescopic boat hook	2022 Boat hook tip	1033 Plastic adaptor	5072 Plastic adaptor	5050 Plastic adaptor with counter plate
Size:	1,17 - 1,96 m	Ø = 25 mm	Ø = 25 mm	Ø = 30 mm	Ø = 25 mm
Material:	Aluminium anodized	Nylon	Nylon	Nylon	Nylon
Delivery :			incl. screws	incl. screws	

Anchor Clearing Hook

Multi-purpose anchor clearing hook...

- Makes it easy to free your anchor if somebody has dropped an anchor line over your anchor chain
- Also can be used as flood hook
- Retrieve your anchor as far as possible
- Includes 3 m spliced lines

Release with the red line remotely.

To be used in conjunction with a SWI-TEC telescopic boat hook, adaptor or boat hook tip.

NEW: You will receive the boat hook adapter free of charge with the delivery!

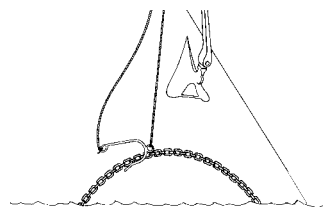
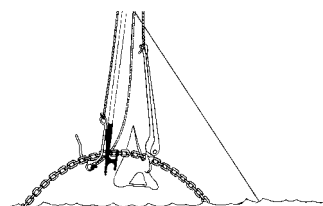

Art. No.	1032
Load:	1000 kg
Supplied with:	2 x 3 m spliced line Ø = 10 mm
Size:	140 x 280 mm
Weight:	0,8 kg
Material:	Stainl. steel (V4A), Ø 12 mm



Line Hook for Lazy-lines

**With this hook docking in a harbour is child's play!
The quickest, easiest and cleanest way to moor!**

To use:

1. Line hook is attached to the Boat hook, reach down or out and snap it over the lazy-line.
2. Then remove the Boat hook and let the Mooring line hook sink to the bottom, holding the lead line, which remains attached to the Mooring line hook and walk to the bow of the boat.
3. Lift the Mooring line and cleat it down.
4. Mooring can't be done more easily or quickly.

To be used in conjunction with a SWI-TEC telescopic boat hook, adaptor or boat hook tip.

NEW: You will receive the boat hook adapter free of charge with the delivery!

- No more barnacle cuts
- No more dirty clothes
- No more dirty deck
- 5 m spliced line

Art. No.	1030
Material:	Stainless steel (V4A)
Load:	500 kg
Supplied with:	5 m line, Ø 10 mm
Size:	160 x 260 mm
Weight:	0,8 kg

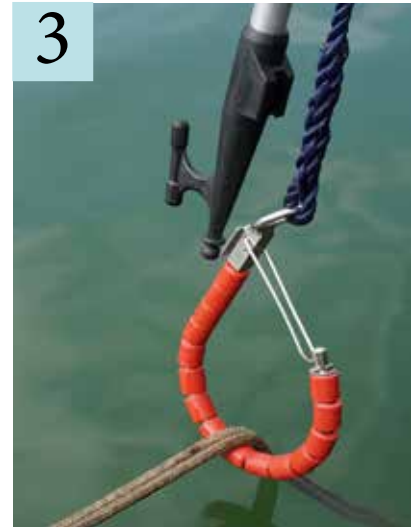
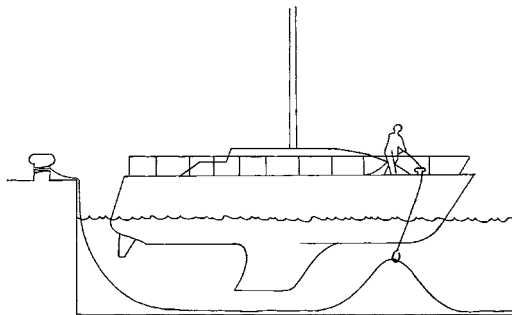
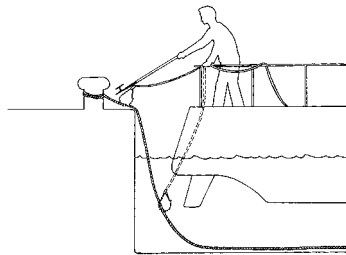

Safety Lock

Easy attaching to bollards, cleats, posts, and locks.

- Perfect to use on sluices and locks
- Multi purpose
- Length of wire rope 1200 mm
- Moor up without leaving the boat
- Release remotely
- 5 m spliced line
- Including a security catch to eliminate accidental release

Art. No.	1036	1037
Safety Lock:	1200 mm	1500 mm
Material:	High impact plastic, aluminium and stainless steel (V4A)	
Load:	1000 kg	
Weight:	1,2 kg	
Supplied with:	5 m, Ø 12 mm; 5m, Ø 4 mm - polyester rope	
Size:	60 x 30 x 120 mm	

To be used in conjunction with a SWI-TEC telescopic boat hook, adaptor or boat hook tip.

NEW: You will receive the boat hook adapter free of charge with the delivery!



Sun Awning Kit with telescopic tube

Our sun sail system is suitable for motor and sail boats!



Shade on board with our awning system

Many boats have no sun protection and you are at the mercy of the sun, even in the harbor or anchoring at the sea. We all would seek for some shade!

Even if the boats are equipped with a bimini, the same applies to the rear bench seat, or sun lounger at the bow. As the sun's rays become more and more aggressive, sun protection is absolutely important.

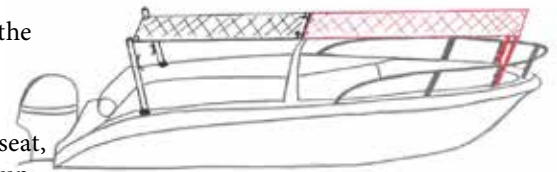

With our flexible system we have the solution for all common sport boats and sailboats. The telescopic tube offers 6 different adjustment options and can be extended up to 190 cm.



We offer the sun sail system for boats with or without railing and also the sun sail in white or blue.

Sun Awning Kit(without awning)

Art. No.	5300	5301	5302	5305	5310
Stanchion:	for Ø 22 mm	for Ø 25 mm	for Ø 30 mm	Deck socket vertical	Deck socket inclined (60°)
Content:	2 telescopic stainless steel tubes (Ø 25mm / length 110 cm - 190 cm) with line, cleat and carabiner.				
Material:	Stainless steel V4A				

Awning made to measure (pro m²)

Art. No.	5340	5341
Colour:	white	blue
Material:	Cotton-poly blend	



Wind Scoop

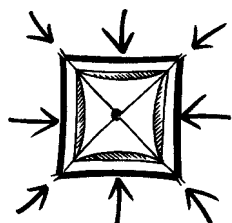

Optimal air circulation from all directions!

The ideal solution in port and at anchor!

- No need to reposition the scoop to face the wind
- The four-chamber system is always drawing air
- Very compact when stowed (incl. bag)
- Special low-noise fabric
- UV-resistant fabric

Tip:

Install a bungee between halyard and windbag to catch the wind scoop.

> Special Mosquito-net for wind scoop available

Easy installation of the wind scoop is guaranteed by using our famous Tenax pull-up fasteners. (Optional set of four available)



Wind Scoop

Art. No.	1010	1011
Hatch size:	500 x 500 mm	700 x 700 mm
Material:	Nylon textile, UV-resistant	

Tenax Pull-up Fastener

Art. No.	2010	2011
Sets:	1	4
Material:	Brass chrome plated	



Mosquito-net

No more troublesome flies and mosquitos on board!!

- Easy installation
- The lead-filled beading ensures a close fit
- Fine polyester netting
- Raindrops run off

> Also available for our Wind Scoop

Tip:

Chose mosquito-net one size bigger than your hatch size!



Art. No.	1091	1093	1094	1098
Size:	540 x 540 mm	620 x 620 mm	700 x 700 mm	for Wind Scoop Art. No. 1010/1011
Material:	Special fine polyester web with lead inlays			



FixTop - Sun Shade

Further development of our well-tried Sun Shade!

- Rain or Sun protection
- «Multitex» fabric
- Optional mounting kit - 6x white straps (3m x 3cm)
- Compact design
- Available in two sizes
- Available white or blue
- UV-stable fabric
- Ideal for either sail or motor boats
- Installed quickly and easily
- Stretchable fabric
- With mounting stand it can be used as sun shade



«Standard»

Art. No.	5074	5076
Size:	1900 x 2300 mm	1900 x 2300 mm
Colour:	white	blue
Material:	alum. anodised	
Textile:	Multitex	
Volume:	1250 x 120 x 120 mm	
Weight:	ca. 2 kg	

«Special»

Art. No.	5075	5077
Size:	2500 x 3000 mm	2500 x 3000 mm
Colour:	white	blue
Material:	Aluminium eloxiert	
Textile:	Multitex	
Volume:	1550 x 120 x 120 mm	
Weight:	ca. 3 kg	

Accessories

Art. No.	5078
Mounting kit for FixTop, all sizes, 6x white straps (3m x 3cm)	
Art. No.	5079
Feet, anodized aluminium (1,2 – 2 m)	



RollTop - simple roll-out system

The Ultimate Sun Protector!

- Quick installation
- Wide range of applications
- Just pull out and secure
- Up to 1,9 m long
- Ideal for either sail or motor boats
- Waterproof UV-stable fabric- come rain or shine
- Different mounting options (Fastening with a belt / Attachment with bracket / Wall mounting) the accessories are included

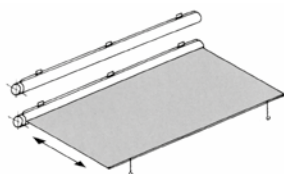

Art. No.	5088
Colour:	white
Length:	1700 mm
Total length:	1900 mm
Diameter:	Ø 40 mm
Weight:	2 kg



Winch Cover (Set of 2)



Protect your winches against moisture and dirt!

- Ideal protection for winches
- Easy to install
- Available in white or blue
- Available in XL!



Art. No.	Colour	Size	Winch Diameter	Height
1049	white	S	80 – 140 mm	18 cm
1046	blue	M	140 – 200 mm	25 cm
1051	white	M	140 – 200 mm	25 cm
1047	blue	L	200 – 250 mm	33 cm
1053	white	L	200 – 250 mm	33 cm
1054	blue	XL	240 – 320 mm	36 cm
1055	white	XL	240 – 320 mm	36 cm

Material: Acryl with UV resistant coating
Washable at 40 °C



Turnbuckle Cover (Set of 2)



No more torn sails and no more injuries caused by loose shroud tensioners!

- New design
- Split design for easy installation
- No re-rigging or / adjustment
- Quick to install
- Durable UV stable fabric
- Easy to clean



Art. No.	6010	6011	6012	6013
Length:	300 mm	400 mm	500 mm	600 mm
Material:	PVC, special UV-resistant, 40° C washable			



Burglar Bars for Hatches



Burglar Bars for hatches – day or night!

- No more stale air, when you return on board
- Easy to use
- Works with wide range of hatch shapes
- Solide stainless steel construction (V4A)
- Can be used in conjunction with Windbag or Mosquito-net
- Available in three sizes
- Including waterproof storage bag



Accessories

Art. No.	1110	1111	1112
Size of hatch:	300 – 450 mm	450 – 550 mm	600 –700 mm
Material:	Stainless steel V4A		

Art. No.	1115
	Stainless padlock



Installation height of the hatch burglar protection system: max. 130 mm

SWI-TEC Emergency Ladder



Safety on board! New Model!

- Releasable from the water
- Usable as everyday boarding ladder
- Adjustable height
- Fits to any rail
- Length 2,5 m (steps are under water, too)
- 7 strong steps of GFK
- Compact design
- With handles on both sides



Art. No. 6005	Model with handles
Size:	500 x 300 mm
Length:	2,5 m
Weight:	2.7 kg
Steps:	7 units, 40 cm long
Material:	Nylon, webbed belt polyester, steps polyester



Sailboat-Burglar Lock «Standard»

Secure your boat against break-ins while you are out!

- Solid stainless steel construction (V4A)
- D.I.Y. installation
- Universal fitting for all sailboats
- Easy to use: just fit the bolt and close

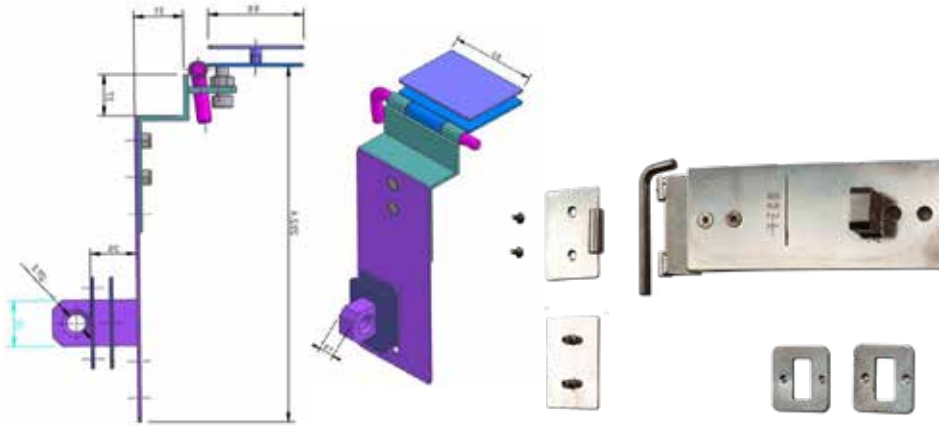

Art. No.	1042
Size:	60 x 80 mm (coverplate) 240 x 80 mm (lockplate)
Weight:	950 g
Material:	2 mm stainless steel (V4A)



Sailboat-Burglar Lock «Deluxe»

Further development!

Secure the companionway from inside!

- Developed from the basic Sailboat Burglar Lock
- Allows locking from inside and outside

Art. No.	1043
Size:	60 x 80 mm (coverplate) 240 x 80 mm (lockplate)
Weight:	950 g
Material:	2 mm stainless steel (V4A) with inside fastener

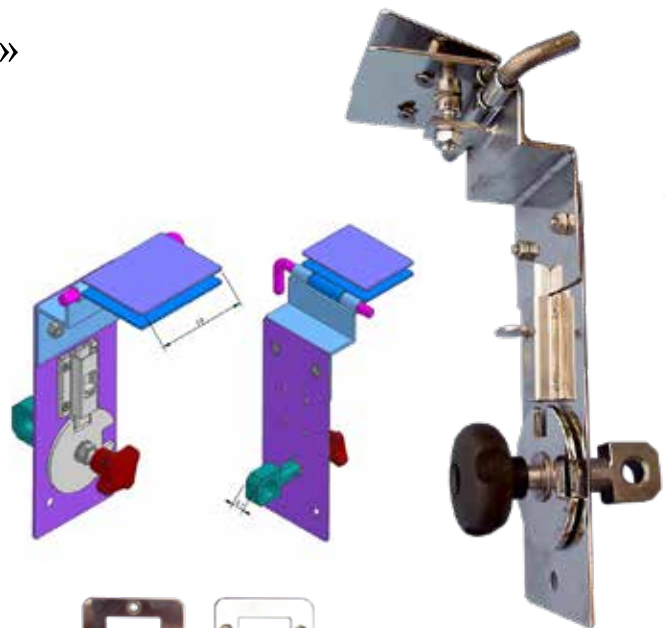

Accessories

Art. No.	2040
	Rustless security lock



Gangway «New-Mini»

- 2 Meter
- 1x or 2x foldable
- Aluminium / Teak-Wood (Iroko)



Gangway «Light»

- 2 or 2,5 Meter
- 1x or 2x foldable
- Aluminium / Teak-Wood (Iroko)



Gangway «Classic»

- 3 Meter
- 1x or 2x foldable
- Aluminium / Teak-Wood (Iroko)



**All Gangways are supplied with deck sockets and wheels.
The Gangways «Light» and «Classic» are equipped with
handrails on one side.**



**Custom made
Custom sizes built to order!**



Light and solid Gangways!

- A wide variety of models
- «New-Mini» model for small boats, only 8 kg
- «Light» & «Classic» models offer increased strength and durability
- «Light» & «Classic» models available in Teak-Wood (Iroko)
- Non-slip surface
- Includes stainless steel deck socket for onboard installation
- Made of anodized aluminium and marine grade stainless steel
- Available in 1x or 2x folding versions
- Length 2 m, 2,5 m or 3 m
- Custom sizes built to order
- Separate deck sockets available on request
- Pin diameter (New-Mini = Ø 20mm, Light & Classic = Ø 30 mm)



Teak Steps (Iroko)



The railing of the Light and Classic models is located on the left side when going up. Changes on request.

Art. No.	Model	Foldable	Material	Length	Width	Weight	Max. Load	Height*	Length*
8070	«New-Mini»	1x	Aluminium	2 m	28 cm	8 kg	ca. 120 kg	10,5 cm	1,10 m
80701	«New-Mini»	1x	Teak Steps (Iroko)	2 m	28 cm	10 kg	ca. 120 kg	10,5 cm	1,10 m
8072	«New-Mini»	2x	Aluminium	2 m	28 cm	8 kg	ca. 120 kg	16 cm	0,74 m
80721	«New-Mini»	2x	Teak Steps (Iroko)	2 m	28 cm	11 kg	ca. 120 kg	16 cm	0,74 m
8045	«Light»	1x	Aluminium	2 m	32 cm	11 kg	ca. 120 kg	12 cm	1,11 m
8046	«Light»	1x	Aluminium	2,5 m	32 cm	13 kg	ca. 120 kg	12 cm	1,31 m
80511	«Light»	1x	Teak Steps (Iroko)	2 m	32 cm	14 kg	ca. 120 kg	12 cm	1,11 m
80521	«Light»	1x	Teak Steps (Iroko)	2,5 m	32 cm	15 kg	ca. 120 kg	12 cm	1,31 m
8061	«Light»	2x	Aluminium	2 m	32 cm	12.5 kg	ca. 120 kg	18 cm	0,77 m
8062	«Light»	2x	Aluminium	2,5 m	32 cm	14.5 kg	ca. 120 kg	18 cm	1,01 m
80631	«Light»	2x	Teak Steps (Iroko)	2 m	32 cm	15.5 kg	ca. 120 kg	18 cm	0,77 m
80641	«Light»	2x	Teak Steps (Iroko)	2,5 m	32 cm	16.5 kg	ca. 120 kg	18 cm	1,01 m
8047	«Classic»	1x	Aluminium	3 m	44 cm	22 kg	ca. 150 kg	14 cm	1,60 m
80531	«Classic»	1x	Teak Steps (Iroko)	3 m	34 cm	24.5 kg	ca. 150 kg	14 cm	1,60 m
8066	«Classic»	2x	Aluminium	3 m	44 cm	22 kg	ca. 150 kg	21 cm	1,18 m
80651	«Classic»	2x	Teak Steps (Iroko)	3 m	34 cm	25.5 kg	ca. 150 kg	21 cm	1,18 m

* when folded



Gangways Accessoires: Non-slip mat for gangway

Advantages

- Allow people to pass safely over the gangway
- Bring small children to the deck without danger or accidents
- Safe grip in wet conditions
- Simple assembly and disassembly
- Thickness 4-5mm
- UV and ozone resistant
- Resistant to wind and weather
- Hard-wearing and tear-resistant
- Relieves legs and joints
- Dimensionally stable and abrasion resistant
- Perfect for animals on board
- Included 12x pieces of velcro (2,5cm x 2,5cm) for SWI-TEC gangway models



Art. No.	for Gangway
8073	„New-Mini“ 2m
8074	„Light“ 2m
8075	„Light“ 2,5m
8076	„Classic“ Alu 3m
8077	„Classic“ Teak 3m
8120	40cm / per meter
8122	60cm / per meter
8125	80cm / per meter
8130	120cm / per meter
8079	Velcro strap 3M transparent per meter



**Perfect for dogs and cats on board.
The material takes away the fear of
running over the gangway!**

Bags for Gangway



Art. No.	for Gangway (100% PVC)
8091	2 m, folding
8090	2 -2,5 m, 2x folding
8092	2,5 m, folding
8093	3 m, folding



Gangway Bracket



- Solid and robust, easy to attach
- Keeps gangway free of ropes
- Unbreakable stainless steel V4A

Art. No.	1090
Material:	Stainless steel(V4A)
Size:	530 x 180 mm
Weight Load:	approx. 500 kg



Gangway Accessoires: Gangway Holder

Stern Mount for Gangway



8097



80461/80471
80701/80532



Art. No.	for Gangway	Size	Fix/Removable
80702	«New Mini»	318 x 60 x 76 mm	Fix
8097	«Light» 2+2,5m	360 x 80 x 82 mm	Removable
80461	«Light» 2+2,5m	378 x 80 x 96 mm	Fix
80471	«Classic» 3m Alu	498 x 80 x 106 mm	Fix
80532	«Classic» 3m Teak	398 x 80 x 100 mm	Fix

Rail fitting for Gangway (V4A) Attaches to all rails up to 30 mm diameter



8036 - 8038

Art. No.	Core diameter	for Gangway
8036	Ø = 20 mm	«Mini»
8037	Ø = 25 mm	«other models»
8038	Ø = 30 mm	«Light» + «Classic»

- Facilitates installation at stern or side-deck
- Variable angle of inclination

Rail fitting horizontal Attaches to all rails with 25 mm diameter

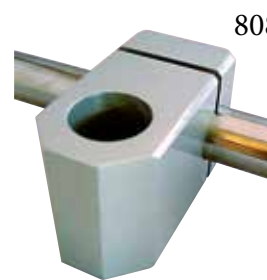

8080 - 8082

Art. No.	Core diameter	for Gangway
8080	Ø = 20 mm	«Mini»
8081	Ø = 25 mm	«other models»
8082	Ø = 30 mm	«Light» + «Classic»

Size: 950 mm x 600 mm x 500 mm
Material: Aluminum anodized

Deck socket for Gangway (V4A)

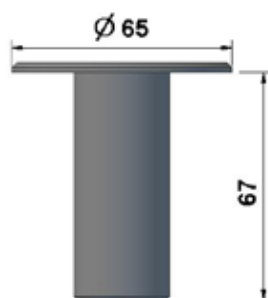

Art. No.	Size	for Gangway
8039	Ø = 20 mm	«Mini»
8058	Ø = 22 mm	«other models»
8059	Ø = 25 mm	«other models»
8060	Ø = 30 mm	«Light» + «Classic»

Storage bracket for Gangway (V4A)

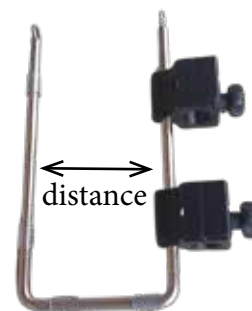

Art. No.	for Gangway folding	
8033	«Mini»	distance: 110 mm
8034	«Light» (only for 1x foldable)	distance: 140 mm
8032	«Classic»	distance: 170 mm

Our accessories can also be used with other makes of gangways. Just let us have the diameter of your gangway fitting.



Toolbag

Do away with an unwieldy, impracticable and cluttered tool box!

- Toolbag available in two sizes!
- 20/30 pockets of various sizes
- Additional small bag with zip-fastener
- Adjustable strap
- Compact design
- Tools secured with velcro
- All tools are easy to find
- 40° C washable



Art. No.	1062	1067
Colour:	blue	blue
Size:	840 x 450 mm	540 x 450 mm
Material:	Nylon	Nylon
Classifications:	30	20



Our tip:
 We recommend the small tool bag for tools for daily use and the large bag for general tools.



Combi bag

All in one bag

- 4 individual pockets
- Perfect for small boats
- For winchhandle, charts, etc.

Art. No.	6058	60581
Colour:	white	silver
Size:	470 x 360 mm	470 x 360 mm
All bags supplied with suction cups and screws!		



Universal bag mini

Fast storage

- with elastic band
- Attaching with screws or lines
- 1 compartment for universal use

Art. No.	6059
Colour:	white
Size:	28 x 28 cm
All bags supplied with suction cups and screws!	



Bag for maps

The ideal bag for maps

- 4 individual pockets
- Can be mounted on a rail or on the wall with suction cups or screws

Art. No.	6059	60591
Colour:	white	silver
Size:	440 x 320 mm	440 x 320 mm
All bags supplied with suction cups and screws!		



Made from indestructible material - suitable for inside and out!

- Strong
- UV-resistant
- Breathable, waterproof, netting fabric
- Rot-proof
- 30°C washable
- Recyclable
- Weatherproof
- Bags delivered with fittings (suction cups, screws, suction cups)
- Available in colour white and now also in silver
- Choice of attaching with screws or suction cups

Special sizes available on request!

Universal storage bag

Storage bag

- Available in two sizes
- 4 / 6 individual pockets
- Fastener (Tenax)



Art. No.	6051	60511
Colour:	white	silvegrey
Size:	600 x 420 mm	600x420mm

All bags supplied with suction cups and screws!

Storage bag

Universal storage bag

- To fit on the galley or bathroom wall
- Suction cups and screws included



Art. No.	6057	60571
Colour:	white	silver
Size:	380 x 250 mm	380 x 250 mm
Art. No.	6050	60501
Colour:	white	silver
Size:	500 x 250 mm	500 x 250 mm

Mast Sheet Bag for halyard

Assures a tidy boat

- Easy mounting at the mast with 2 fastening buckles
- Quick stowage of halyards and therefore less chaos on bord
- No danger of loose ropes
- Easy handling



Art. No.	6060	60601
Colour:	white	silver
Size:	550 x 220 x 160 mm	

All bags supplied with 2 fastening buckles



Multi-purpose bag

Ideal for drinks, GPS, mobiles etc...

- Also suitable for bottles
- Can be mounted on a rail or on the wall with suction cups or screws

Art. No.	6056	60561
Colour:	white	silver
Size:	210 x120 mm	210 x120 mm

All bags supplied with suction cups and screws!



Storage bag for winch handle

Storage bag for winch handle

- Available in two sizes
- Can be mounted on the mast or in the cockpit with screws

Art. No.	6053	60531
Colour:	white	silver
Size:	320 x 110 mm	

Art. No.	6054	60541
Colour:	white	silver
Size:	400 x 130 mm	

All bags supplied with screws!



Storage bag for ropes

Small and large bag for sheets and halyards

- Available in two sizes (350 x 280 mm & 400 x 350 mm)
- Ropes will dry very fast, due to special netting
- No mold growth

Art. No.	6055	60551
Colour:	white	silver
Size:	350 x 280 mm	350 x 280 mm

Art. No.	6052	60521
Colour:	white	silver
Size:	400 x 350 mm	400 x 350 mm

All bags supplied with suction cups and screws!



Exclusive Designs for the kitchen



At home or on board; Garlic-Press, Salt and Pepper Shakers

- In stainless steel and aluminium
- You can press more than 1 garlic clove at once
- No garlic spillage
- The garlic remains in a small case and remains clean
- Smoother than all the other presses (like butter)
- You can press the clove without peeling

Garlic press

Art. No.	9120
Diameter:	300 x 50 x 120 mm
Weight:	1,8 kg
Material:	steel / Alu

Pepper shaker

Art. No.	9111
Diameter:	39 mm
High:	46 mm
Material:	steel

Salt shaker

Art. No.	9106
Diameter:	39 mm
High:	46 mm
Material:	steel

Perfect gift for every sailor!



Salt & Pepper shaker + wood

Art. No.	9112
Size:	95 x 65 x 55 mm

Drink- and Bottleholder for Guard Rails and Stanchions



Drinkholder



Bottleholder

Now drinks and bottles are at hand all the time!

- Easy and fast to fit
- Usable on the guard rail and on the stanchion
- You can attach up to 2 litre bottles
- Available as drink- or bottle-holder
- With a special adapter bushing (accessories) it is also usable on life-lines
- Available for stanchion diameter 25mm
- To attach just put-it on the guard rail or stanchion, turn-it by 90° and the holder clips on and it is attached
- An ideal present
- Polyethylene / stainless steel 316
- Weight: 250 g

Video Demo
www.swi-tec.com



Drinkholder for stanchion

Art. No.	tube-Ø
7900	25 mm

Bottleholder for stanchion

Art. No.	tube-Ø
7902	25 mm

Bushing for life-lines

Art. No.	7905
Material:	Rubber
Size:	L: 5,5cm, Ø 2,5 cm

Universal Drink Holder Set of 2

The practical solution for glasses, tins, bottles and other things!

Universal Drink Holder

- Set of two drink holders
- No more spilled drinks
- Individual fittings
- Also holds handheld GPS, VHF etc.
- Easy to attach
- For bottles up to 1,5 l
- Also perfect for use in other areas such as camping, household, workshop, garden and much more.



Art. No.	6045
Size:	For drinks up to max. Ø 100 mm
Supplied with:	Set of 2 straps, 2 screw snaps and 2 suction cups
Material:	PVC, Velcro fastener

Universal screw carry case

Universal screw carry case, Stainless steel VA4, AISI 316.

- Screws metric, split-pin, spring washer
- Appr. 360 pieces
- Easy to see
- Ideal on board or at home
- Easy to store
- Ideal gift for the skipper

Art. No.	7001
Size:	320 x 260 x 50 mm
Weight:	1,8 kg
Material:	stainless steel V4A, 316

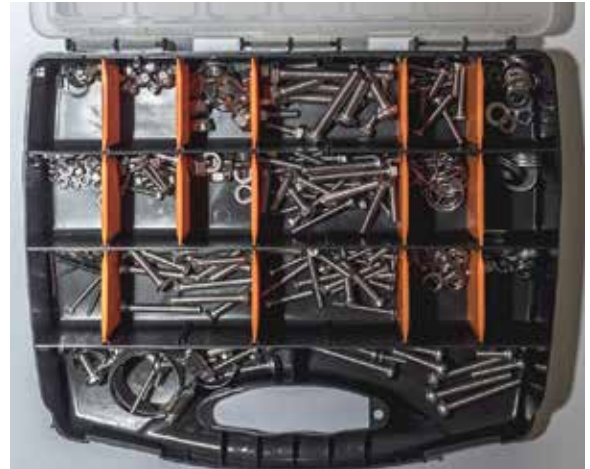

Sheet metal screws set

Sheet metal screws set Stainless steel VA4, AISI 316.

- Different sizes
- Set includes 430 pieces
- Easy to see
- Ideal on board or at home
- Easy to store
- Ideal gift for the skipper

Art. No.	7007
Size:	320 x 260 x 50 mm
Weight:	1,7 kg
Material:	stainless steel V4A, 316

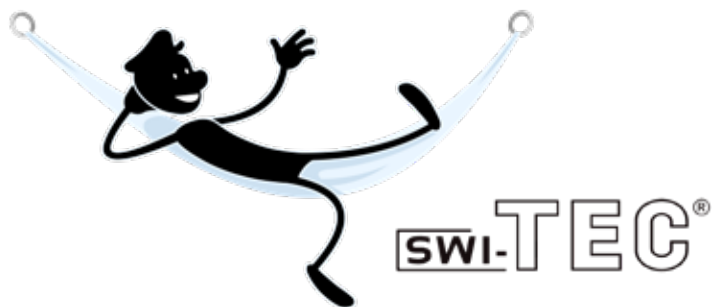



**WE PRODUCE 80% OF OUR RENEWABLES
AND SAVE
7.34 TONS CO₂ PER YEAR**



A extract of our work you will find all on our website or on our Social Media channels. We hope you will enjoy browsing through it!



WhatsApp
+34 971 82 24 26
(only Chat)



SWI-TEC International



©fotomek/fotolia.com

International - Worldwide

www.swi-tec.com

Distributors:

www.swi-tec.fr

www.swi-tec.us

www.swi-tec.ch

www.swi-tec.es

www.swi-tec.it

www.swi-tec.de

www.swi-tec.nl

www.swi-tec.es

You will find explicit information about all our distributors on our website
www.swi-tec.com below *Dealerlist*.



SWI-TEC[®]

ALWAYS AN IDEA AHEAD



WWW.SWI-TEC.COM

